



SEA®

Sistemi Elettronici
di Apertura Porte e Cancelli
International registered trademark n. 804888



Italiano

English

Français

Español

Deutsch

USER 1 - 24V

23024060/65

APPAR. ELETTRONICA 24V=== PER CANCELLI SCORREVOLI E BARRIERA
24V=== ELECTRONIC CONTROL UNIT FOR SLIDING GATES AND BARRIERS
ARMOIRE ELECTRONIQUE 24V=== POUR PORTAILS COULISSANTS ET BARRIERES
DISPOSITIVO ELECTRÓNICO 24V=== PARA CANCELAS CORREDIZOS Y BARRERAS
ELEKTRONISCHE 24V STEUERUNG=== FÜR SCHIEBETORE UND SCHRANKEN

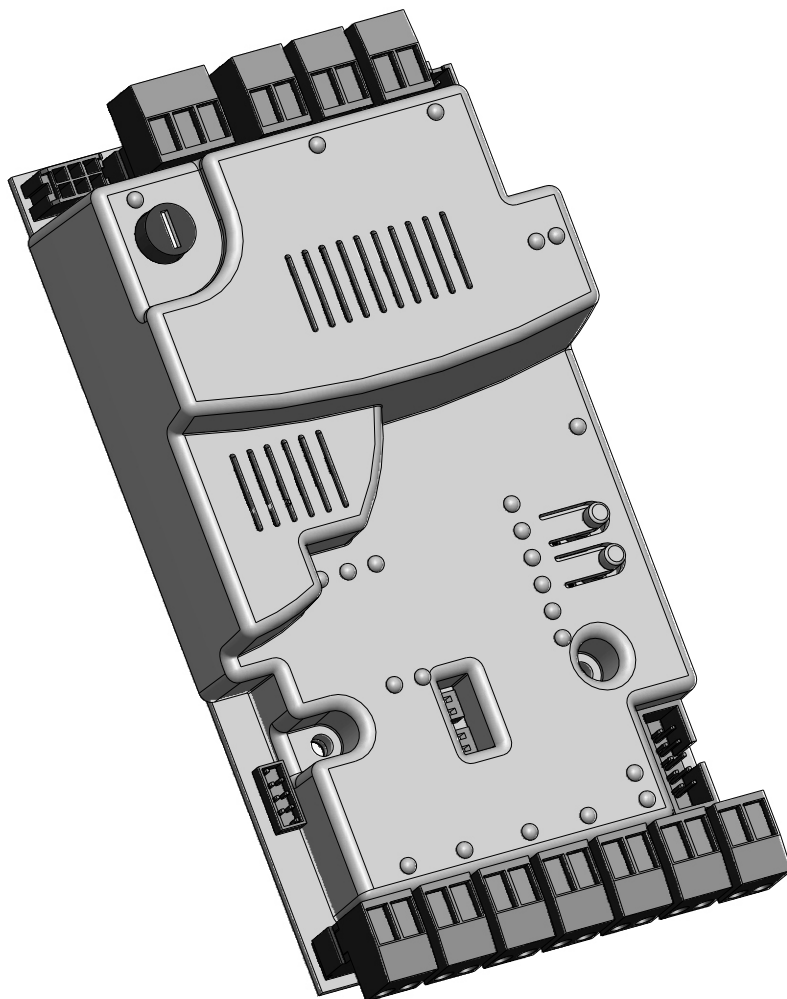

SEA s.r.l.
Zona Ind.le S. Atto - 64020 S. Nicolò a Tordino (TE)
Tel. 0861.588341 - Fax 0861.588344

www.seateam.com

e-mail: seacom@seateam.com



CONNESSIONI / CONNECTIONS / CONNEXIONS

CONEXIONES / VERBINDUNGEN

M1

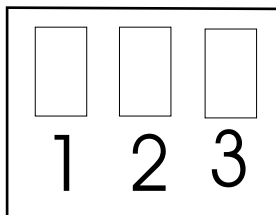

Solo con scheda
caricabatteria / Only with
battery charger card /
Seulement avec
chargeur batterie / Solo
con tarjeta cargabaterias
/ Nur mit
Batterieladekarte
(Cod.23101105)

28V --- Caricabatterie
28V --- Battery charger
28V --- Chargeur de batterie
28V --- Cargabaterias
28V --- Batterie-ladegerät

Positivo batteria/Positive battery
Positif batterie/Positivo Bateria
Positiv Batterie

Negativo caricabatteria/
Negative battery charger
Négatif chargeur batterie
Negativo cargabaterias
Negativ Batterieaufladegerät

M2

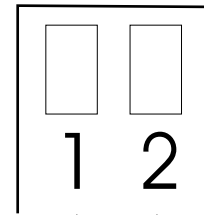

+
-

24V --- Accessori Max 200 mA
24V --- Accessories Max 200 mA
24V --- Accessoires Max 200 mA
24V --- Accesorios Max 200 mA
24V --- Zubehör Max 200 mA

M3

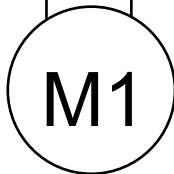
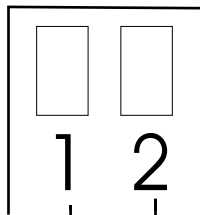

M4

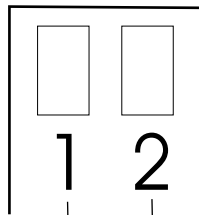

Lampeggiatore 24V --- 15W /
Flashing lamp 24V --- 15W
Lampe clignotante 24V --- 15W /
Lampara 24V --- 15W /
Blinklampe 24V --- 15W

M5

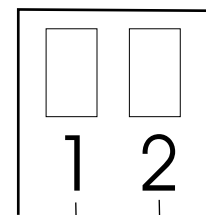

Antenna / Antenna /
Antenne / Antenna /
Antenne
Comune / Common /
Comun / Comune /
Gemeinsam

M6

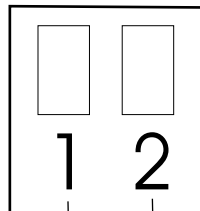

START
Comune / Common
/ Comun/Comune/
Gemeinsam

M7

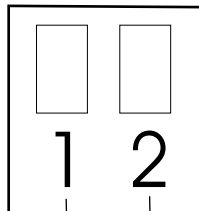

START Ped./ START Ped. /
START Ped/START Ped./
START Fuss.
Comune / Common /
Comun/Comune/
Gemeinsam

M8

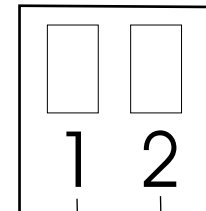

Costa di sicurezza / Safety edge
Tranche de sécurité /
Costa de seguridad /
Sicherheitsleiste
Comune / Common /
Comun / Comune /
Gemeinsam



CONNESSIONI / CONNECTIONS / CONNEXIONS

CONEXIONES / VERBINDUNGEN

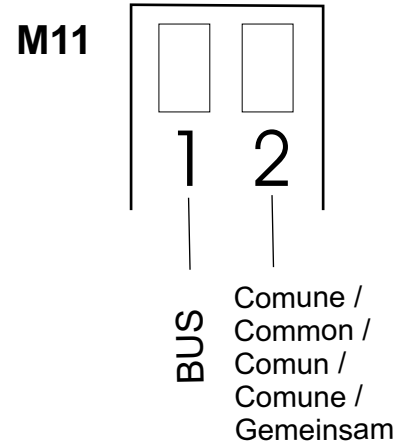
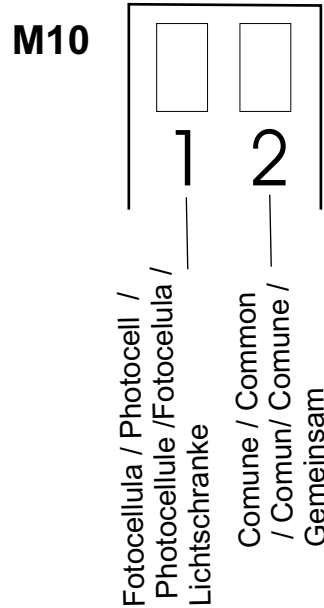
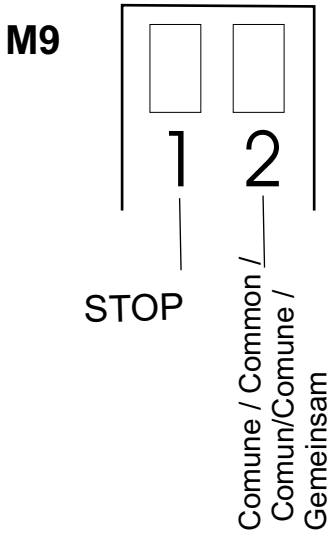

ENCODER

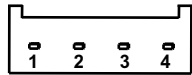

N. C.
Encoder 1 (Verde) / Encoder 1 (Green)
Encoder 1 (Vert) / Encoder 1 (Verde) / Encoder 1 (Grün)
Encoder 1 (Bianco) / Encoder 1 (White)
Encoder 1 (Blanc) / Encoder 1 (Blanco) / Encoder 1 (Weiss)
Comune / Common / Comun / Comune / Gemeinsam
12V

LIMIT SWITCH

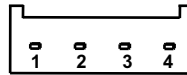

Comune / Common / Comun /
Comune / Gemeinsam
Finecorsa Ap.1 / Limit switch Op.1 /
Fin de course Ouv.1/Final de carrera Ap.1/
Endschalter Öffn.1
Finecorsa Ch.1 / Limit switch Cl.1 /
Fin de course Fe.1/Final de carrera Cie.1 /
Endschalter Schlie.1
+24V ===

PROGR RX

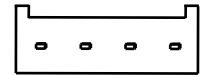

Connettore programmatore OPEN/
Connector programmer OPEN/
Connecteur programmeur OPEN/
Conector Programador OPEN/
Anschluss Programmierer OPEN

RADIO MODULE

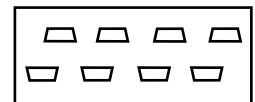

Connettore modulo ricevente /
Receiver module connector /
Connecteur module récepteur /
Conector modulo receptor /
Verbindungsmodul Empfänger

JOLLY

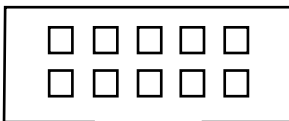

Connettore Programmatore Jolly /
Connector Programmer Jolly /
Connecteur Programmeur Jolly /
Conector Programador Jolly /
Anschluss Programmierer Jolly

POWER

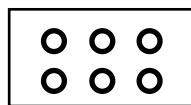

Connettore alimentazione 24V ===/
24V=== feed connector /
Connecteur alimentation 24V ===/
Conector alimentaciùn 24V ===/
Speisungsverbindung 24V ===

DIP SWITCH

Chiusura automatica/
Automatic closing/
Fermeture automatique/
Cierre automatico/
Automatische Schliessung

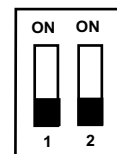

Start in pausa/
Start in Pause/
Start en pause/
Start en pause

Inversione motore/
Motor reversion/
Inversion moteur/
Motorreversion

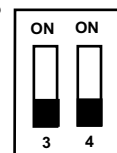

Attivazione dip switch/
Dip Switch activation/
Activation Dip Switch/
Activación dip switch/
Dip switch Aktivierung



INDEX

COMPONENTS' DESCRIPTION	20
GENERAL INFORMATION	21
START, STOP, PEDESTRIAN START, ANTENNA, PHOTOCCELL CONNECTIONS.....	22
ENCODER, LIMIT SWITCH, WARNING LAMP, EDGE	23
POWER SUPPLY AND MOTORS CONNECTIONS	24
SELFLEARNING DEFAULT SETTING	24
WORKING TIMES SELFLEARNING	25
SETTINGS' SELECTION	26
EXTERNAL RECEIVER CONNECTION AND RADIO TRANSMITTER LEARNING	27
FUNCTIONING LOGICS.....	28
BUS SYSTEM DESCRIPTION	28
MASTER SLAVE FUNCTION	29
PROGRAMMER JOLLY PARAMETERS ADJUSTMENT.....	30
CONNECTION OF BATTERIES	32
ALARMS DESCRIPTION.....	32
TROUBLE SHOOTING	33
INSTRUCTIONS, MAINTENANCE AND GUARANTEE	33
TERMS OF SALE.....	79



DESCRIPTION OF THE COMPONENTS

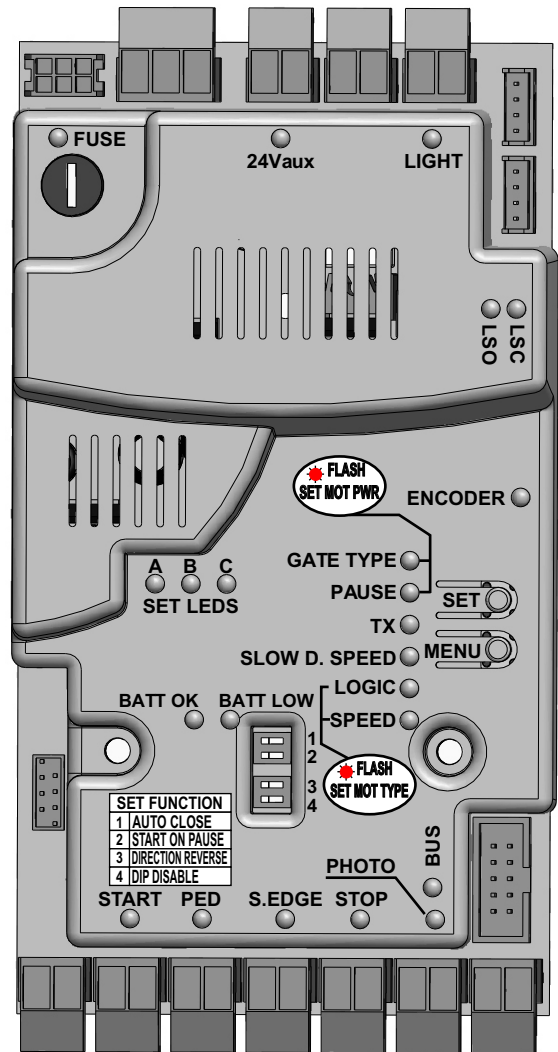
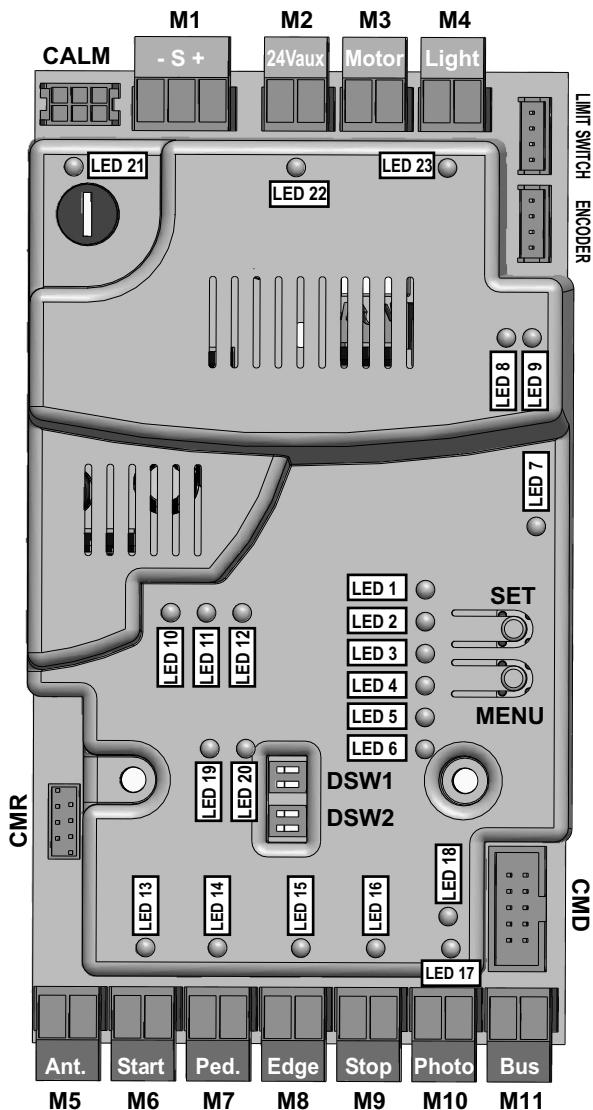

- LED1** = Encoder ON - Encoder OFF
- LED2** = Pause adjustment
- LED3** = TX Programming
- LED4** = Slowdown speed adjustment
- LED5** = Functioning logics
- LED6** = Motors speed
- LED7** = Encoder
- LED8** = Limit switch in opening
- LED9** = Limit switch in closing
- LED10 A** = Led for SET
- LED11 B** = Led for SET
- LED12 C** = Led for SET
- LED13** = Start
- LED14** = Pedestrian Start
- LED15** = Security edge
- LED16** = Stop
- LED17** = Photo
- LED18** = Indicator BUS
- LED19** = Battery Ok
- LED20** = Unloaded Battery
- LED21** = Broken fuse
- LED22** = 24Vaux condition
- LED23** = Warning lamp condition
- SET** = Setting
- MENU** = Selection

- M1** = Connection to battery charger
- M2** = 24Vaux exit ===
- M3** = Motor power supply
- M4** = Warning lamp 24V === 15W
- M5** = Antenna
- M6** = Start
- M7** = Pedestrian start
- M8** = Security edge
- M9** = Stop
- M10** = Photocell
- M11** = BUS
- CNE** = Encoder connector
- CNF** = Limit switch connector
- CMD** = Jolly programmer connector
- CMR** = Receiver module connector
- CALM** = 24V===power supply connector
- CPO** = Programmer connector OPEN
- CRC** = Control unit reprogramming connector
- µC** = Micro-controller
- DSW1** = Automatic closing/Start in pause
- DSW2** = Opening direction/Dip Switch activation



GENERAL INFORMATION

The information in this section of the manual are only for technicians or for qualified or authorized installers.

GENERAL CHARACTERISTICS

The USER 1 24V control unit has been designed to manage one low voltage motor with or without electronic limit switches.

It is of very small dimensions and besides the possibility to adjust motor speed, amperometric anti squeezing sensitivity, leaf delay in closing, pausing time, it is also possible to manage a display, through which it is possible to control a lot of management functions and the maintenance of the control unit. The most important change however concerns the presence of a BUS connector with two wires, through which it is possible to connect accessories as photocells, flashing lamp, key switch and so on,... connecting only two cables with the control unit. The self-learning of working time can be done automatically.

TECHNICAL SPECIFICATIONS

Control unit power supply	24 V ===
Absorption in stand by	90 mA
Max. motor charge	90 W x 2
Max. accessories charge	24V=== 250mA
Max. Flash light charge	24V=== 15W max.
Environment temperature	-20°C ↕ +50°C ↕
Protection fuse (24V accessories)	F1 (2A)
Function logic	Automatic/Step by Step 1/S. By Step 2/Sec./Dead man
Opening/closing time	In selflearning in programming phase
Time of pause	Adjustable
Thrust	Adjustable Opening and Closing
Slow down	Adjustable
Input on connecting terminal	Battery power supply / Total opening / Pedestrian opening adjustable / Edge/ Stop / Limit switch opening and closing / Encoder/ BUS accessories
Output on connecting terminal	Power supply accessories 24V===/ Motors 24V===/ Flashing lamp 24V=== / BUS
Board dimensions	156 x 100 mm
Specifications of optional batteries	24V Pb 2Ah min.
Specifications of external enclosure	305 x 225 x 125 mm - Ip55
Special accessories	Battery charger card (cod.23101105), Relay card for courtesy light or bolt lock (cod.23101106), Programmer JOLLY (cod.23105276), Programmer OPEN (cod.23105290), Photocell SUNSET BUS (cod.23102075)



START - STOP - PEDESTRIAN START - ANTENNA - PHOTOCELL

Photocell 1 Connection

When the ray of the photocell is crossed, and the automation is in phase of closing it reverses its movement.

Note: If the photocell is not connected, put a jumper between the clamps 1 and 2 of (M10).

+ = 24V === - = 0V === C = Connection Com = Common

The photocell is also usable in connection with BUS photocells.

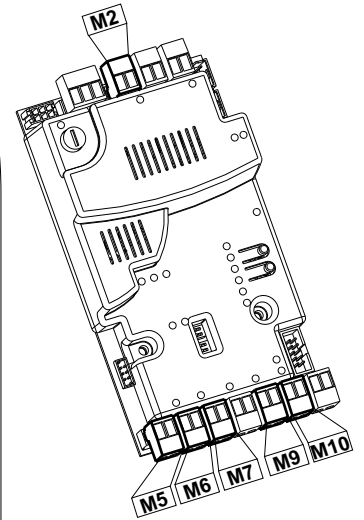

JOLLY OPTIONS

FOTOCLOSE activation: If activated when the photocell is crossed during the pause, the gate interrupts the pause and immediately closes again.

TIMER activation: If the entry is activated it turns into a N.O. entry with TIMER function (see TIMER).

FOTOOPEN activation: If activated the photocell blocks the movement as long as it's busy, when released it opens.

FOT PARK activation: in opening it is not active; when during the pause "closing with photo" and "automatic closing" are activated it commands the closing when released, otherwise it's not active; in closing it stops the movement as long as it is busy, when released the closing continues.

FOTO STOP activation: When activated before the opening the photocell blocks the automation as long as it is busy, during the opening it will be ignored. In closing the intervention of the photocell causes the reopening.

Activation PHOTO CLOSE IMMEDIATELY: The photocell stops the gate as long as it is occupied in both opening and closing, when released it gives a closing command.

24Vaux === max 200 mA



JOLLY OPTION

Through the Jolly programmer it is possible to chose when having tension on the 24Vaux output. The options are: always, only during opening, only during cycle, only before opening or only during pause.

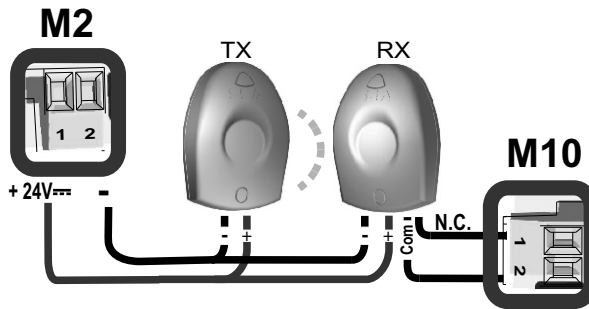

ANTENNA

Connect the antenna as in the figure.

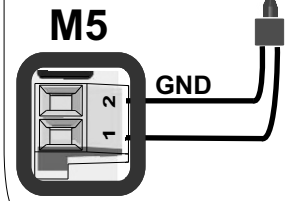

M7

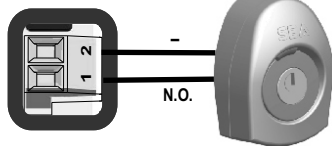

PEDESTRIAN START (N.O.)

To obtain a partial opening connect the key-button wires as in the figure. It is possible to connect other command devices (push button board, radio receiver, keypad).

Note1: The contact for partial opening is a N.O. Contact (Normally open)

Nota2: In manual logic it is necessary to keep pressed the Start Ped. To re-close the automation.



JOLLY OPTIONS

Activation TIMER: this entry can be transformed into TIMER (See TIMER)

Pedestrian opening space: Linearly adjustable from 30% to 100%.

M9

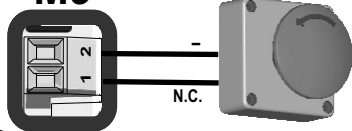

STOP (N.C.)

The pressure on this button immediately stops the motor in any condition/position. A start command is needed to re-start the movement.

After a stop the motor always re-starts in closing.

Note: If the stop button is not used it is not necessary to close the N.C. contact between the clamps 1 and 2 of M9 as the absence of the stop is revealed during the selflearning phase of the times.

M6

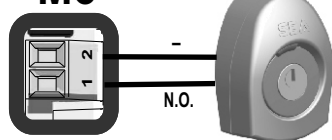

START (N.O.)

An impulse given to this contact opens and closes the automation depending on the selected logic. It can be given by a key switch, a keypad, etc. To connect the other devices refer to the related instructions leaflets. (ie. loop detectors and proximity switches)

Note1: In DEAD MAN logic it is necessary to keep pressed the Start for the opening of the automation.



JOLLY OPTION

Can be activated through the Jolly programmer or modifying either the PHOTO entry or the PEDESTRIAN entry. In both cases it's a N.O. contact which provokes the opening of the automation keeping it open until it is activated. When it's released, the gate attends the set pausing time and executes the reclosing.

Note2: When activated on the pedestrian entry, the pedestrian will be disabled also on the radio transmitter.

Note3: In case of intervention of a security device during the timer (Stop, Ammeter, Edge), to restore the movement it will be necessary to give a start impulse.

Note4: In case of no power supply with open gate and active Timer the control unit will restore its use, otherwise if during restore of the power supply the TIMER is not activated it will be necessary to give a start impulse for the reclosing.

TIMER





ENCODER - LIMIT SWITCH

Encoder / Ammeter sensor

The encoder is a device that allows to reveal possible obstacles during the opening and the closing of the gate. When this device intervenes in opening it causes the inversion of the movement for around a second, if it intervenes in closing it causes the total reopening.

Note 1: Such function is active through an ammeter sensor on the control board. It is not necessary to mount any external devices for the respect of legislation.

Note2: The ammeter sensitivity is adjustable both in opening and in closing through the JOLLY terminal. On the control unit the torque can be adjusted in 4 steps: low, middle, middle high, high and will be the same in opening and closing. With high torque the gate reverses after 5 seconds.

Attention: after each intervention of the ammeter sensor it is necessary to give a start impulse to restore the movement.



JOLLY functions: With the JOLLY programmer the torque parameters can be adjusted linearly from 10% to 100% on each single motor. Furthermore, they are differentiable between opening and closing.

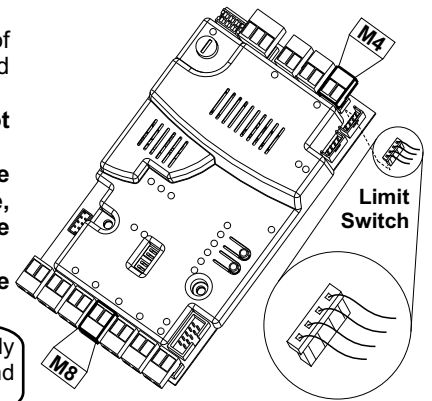

Limit switch

For the functioning the presence of both limit switches in closing and in opening is necessary.

For the right functioning of the limit switch, the movement direction of the motor and the respective busy limit switches must correspond. Through DIP3 it is possible to exchange contemporarily the direction of the motor and of the limit switches.

Note: if during programming phase the motor and limit switch times should not be in phase between them, the gate will start in closing, it stops and will not complete the selflearning of the times, at this point it will be necessary to switch off the tension and to invert the cables of the motor and to eventually exchange the motor direction on DIP 3. The first movement in selflearning must always be executed in closing.

Com = Common
C = Contact



JOLLY functions:

- 1) With the Jolly programmer such function is tied up to the presence of at least one limit switch and it's possible to activate the function anti-intrusion. When the limit switch is free it forces the motor to re-close.
- 2) With the Jolly programmer it is possible to exchange the motor and the limit switch without setting DIP3 of the control unit.

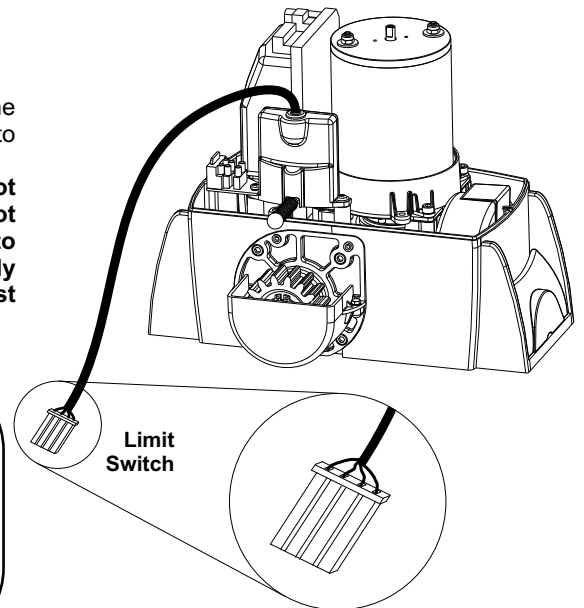

SECURITY EDGE AND WARNING LAMP

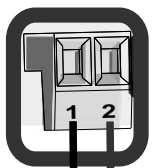

It is possible to connect an active safety edge on the terminal M8. If this device is pressed it opens the contact causing a partial inversion of the movement both in opening and in closing. If not used bridge the contacts 1 and 2 of M8. Note: contact N.C.

M8 Costa di sicurezza



JOLLY FUNCTIONS:

It is possible to activate the balanced edge 8K2, in this case the edge contact will be controlled by a specific value of resistance revealing the eventual unintentional short circuit of the device. In case of an unbalance of the device the corresponding led of the terminal board M8 will flash quickly.

Flashing Lamp 24V === 15W (Warning lamp)

The warning lamp advises that the automatic gate is moving with 1 flash /second in opening and 2 flashes / second in closing. During pause it remains fixed on.

Connect the cables of the warning lamp as shown in the figure. The pre-flashing function can be activated with the Jolly terminal or with Led 4 of the menu through the SET and MENU buttons.

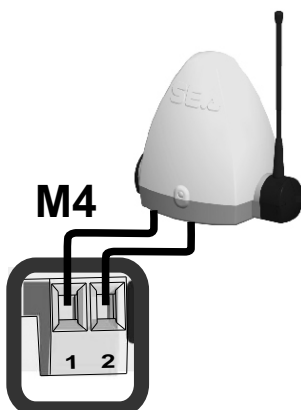

JOLLY functions:

It is possible to activate a pre-flashing of 3 seconds before activating the automation, on setting pre-flashing on ON, through the Jolly programmer. Furthermore from the flashing lamp it is possible to verify some alarm signals. See alarms indications.

Through the Jolly programmer it is possible to set this exit with fixed flashing also when the gate is not moving or it is possible to change this exit into control lamp. In such case all the indications of alarm remain on the warning lamp as long as they are active.



MOTOR POWER SUPPLY

M3

Motor connection

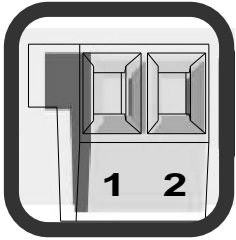

M+M-

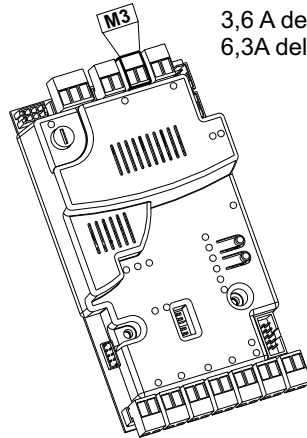

3,6 A delayed fuse on 230V ~ power supply .
6,3A delayed fuse on 115V ~ power supply.

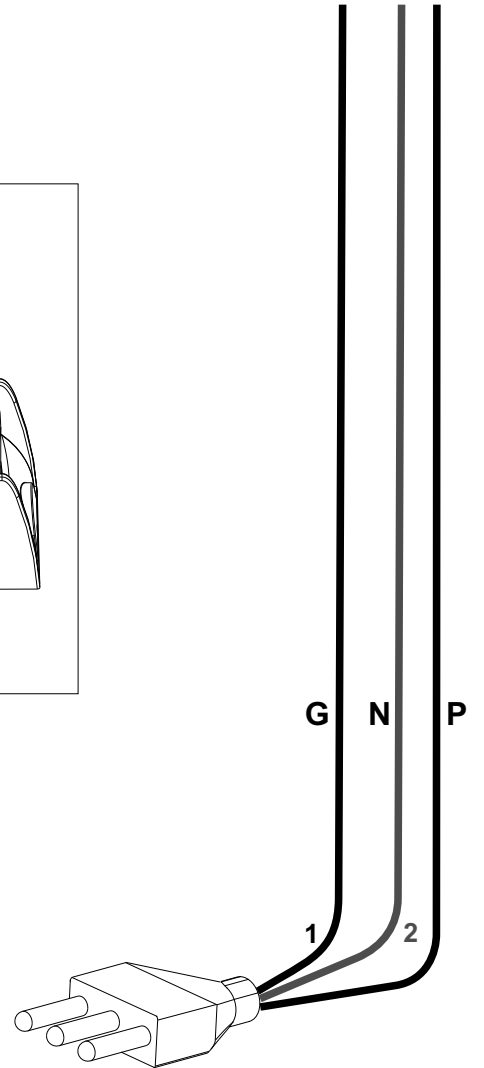
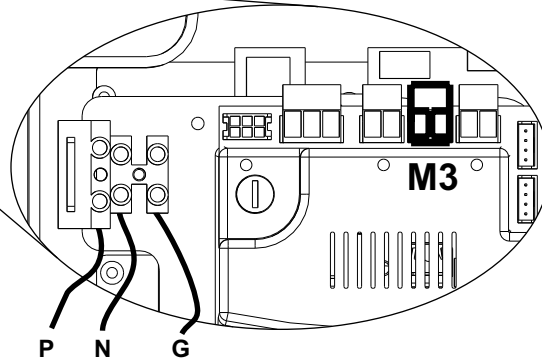
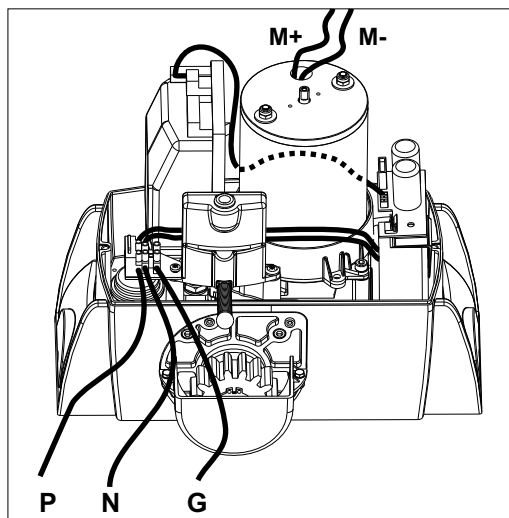
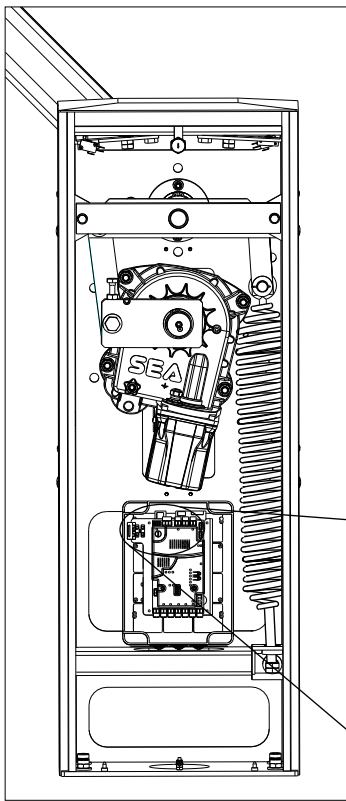
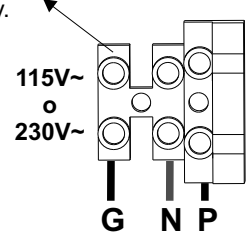

CONFIGURATION FOR VERG

For the application on the VERG it is recommended to use the speed levels indicated on the following board:

LED 10A GREEN	5 m
LED 11B YELLOW	4 m
LED 12C RED	3 m

Power input

Input for the connection of the electric power.

P = PHASE - LIVE

N = NEUTRAL

G = GROUND

NOTICE: for the connection to the electric power see the law in force.

SELFLEARNING WITH DEFAULT PARAMETERS

The control unit is pre-set with the default settings, to learn the working times it is sufficient to press the Menu button once and to hold pressed the SET button until the motors start in closing. The settings of DEFAULT are: AUTOMATIC LOGIC, ENCODER OFF, SPEED 80%, PRE-FLASHING OFF, PAUSE 10S., TORQUE 75%, SLOWDOWN SPEED 40%, LEARNING SPEED 80%, ACCELERATION 70%, DECELERATION 30%, LEAF STROKE OFF, ANTI-INTRUSION OFF, SELFTEST OFF, PEDESTRIAN 30%, PHOTO OPENING OFF, MAX CYCLES 10000, SLIDING MOTOR TYPE, WARNING LAMP NORMAL, PHOTO/TIMER OFF, PEDESTRIAN/TIMER OFF, CLOS.FOTO OFF, BALANCED EDGE OFF, 24Vaux ALWAYS, START IN PAUSE OFF, AUTOMATIC CLOSING OFF. IF YOU WANT TO RESTORE THE DEFAULT SETTINGS JUST SWITCH ON THE CONTROL UNIT KEEPING PRESSED THE BOUTONS MENU AND SET CONTEMPORARILY.



WORKING TIMES SELF LEARNING

Note1: it is not necessary to put a jumper between the STOP, PHOTOCELL contacts if they are not used. If they are used during selflearning phase they must stay (N.C.).

Note2: If accessories are connected on the BUS, align the photocells before programming, as shown in the description of the BUS system.

1) Make sure that each accessory (photocells, push buttons, and so on) works properly.

2) If necessary adjust the self-learning speed through the palm user.

3) Disconnect the power supply (Fig. 1), release the motor (Fig. 2) and put the leaves manually next to the stop in closing (Fig. 3-4). Reset the mechanical lock (Fig. 5)

4) Connect the control board to the power supply (Fig.6).

5) Select the desired type of motor; use as shown on pag. 26 or through JOLLY programmer.

6) Press the button "SET" until the led of the color corresponding to the type of application (Encoder ON, Encoder OFF) switches on.

7) Hold pressed the button "SET" until the motor starts in closing and then release the button.

Note: If FOTOBUS are present, check their alignment and give a new impulse on SET to start the programming.

Note: If the motor starts in opening, switch of the power supply and set DIP 3 on ON or if you have a Jolly terminal, activate the motor and limit switch exchange function. If the motor starts in closing and stops, switch off the power supply and invert the cable of the motor, afterwards repeat the procedure starting from step 4.

Note: If you do not have a Jolly terminal the functions of the DIPs on board of the control unit can be activated setting DIP4 on ON. If DIP4 is activated the functions which can be activated through DIP cannot be changed through the Jolly terminal.

8) The motor will close with the set speed.

9) After having reached the limit switch of closing it automatically will execute an opening cycle (Fig.7). After having reached the limit switch in opening it will automatically execute a closing cycle.

10) Wait for the end of the closing of the leaf (Fig.8). The self-learning is done.

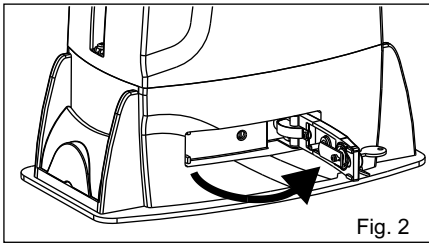
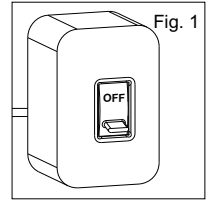

Fig. 2

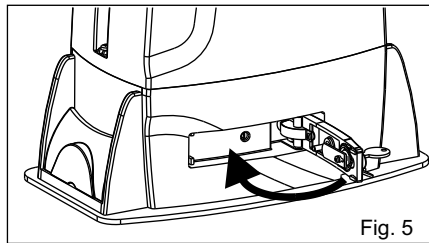

Fig. 5

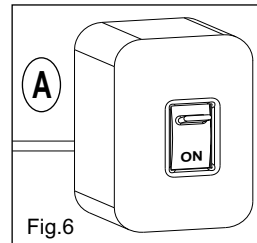

Fig.6

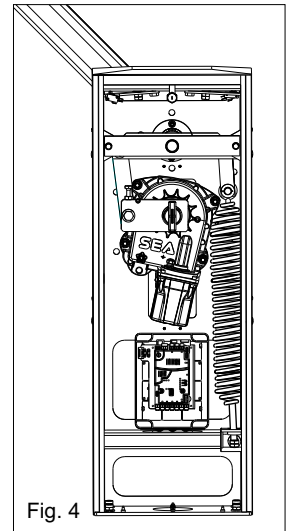

Fig. 4

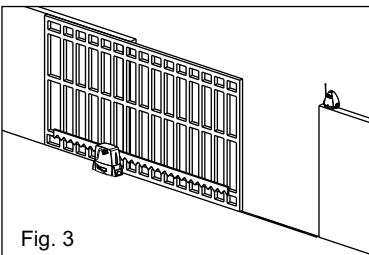

Fig. 3

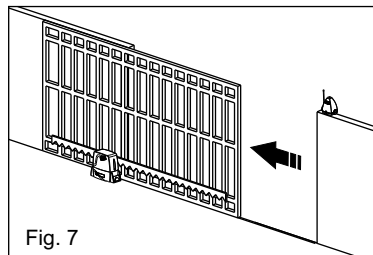

Fig. 7

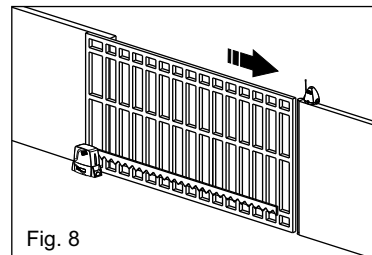

Fig. 8

A) Select LED 1 of the self-learning through the MENU button, with LED 1 turned on press button SET to choose the function modality:
-Led L10 A green on = Encoder ON
-Led L11 B yellow ON = Encoder OFF

B) Once the functioning modality has been chosen, always with Led10 A switched on, hold pressed SET up to the departure of the motors in closing and then release the button.

A) Press the "Menu" button so that to turn on the LED1

B) Press the "IMP" button till the Led of the colour which corresponds to the type of installation (Encoder ON or Encoder OFF) turns on.

Keep pressed the button "SET" till the departure of the motor in closing and then release the button.

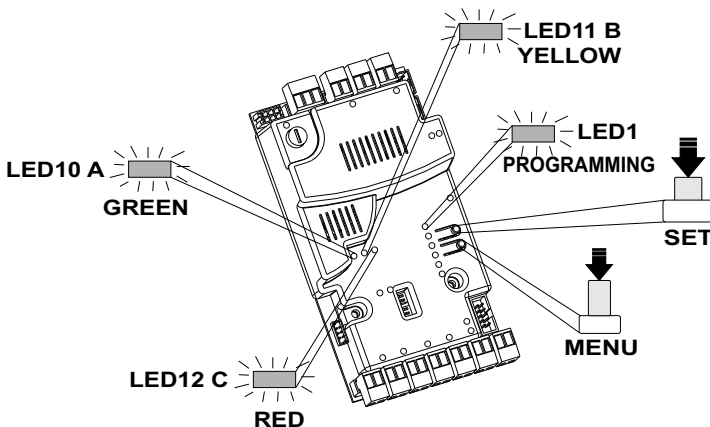

JOLLY functions:
1) With the JOLLY programmer it is possible to start the programming without using the MENU and SET bouton.
2) With the JOLLY programmer it is possible to choose the type of motor and the type of application without using the MENU and SET boutons.



SELECTION OF THE SETTINGS

The adjustments of the control unit are executed through the buttons "MENU" and "SET". Pressing the "MENU" button you select the Leds corresponding to the various functions to be set, pressing the "SET" button you select the leds corresponding to the desired values inside every single function.

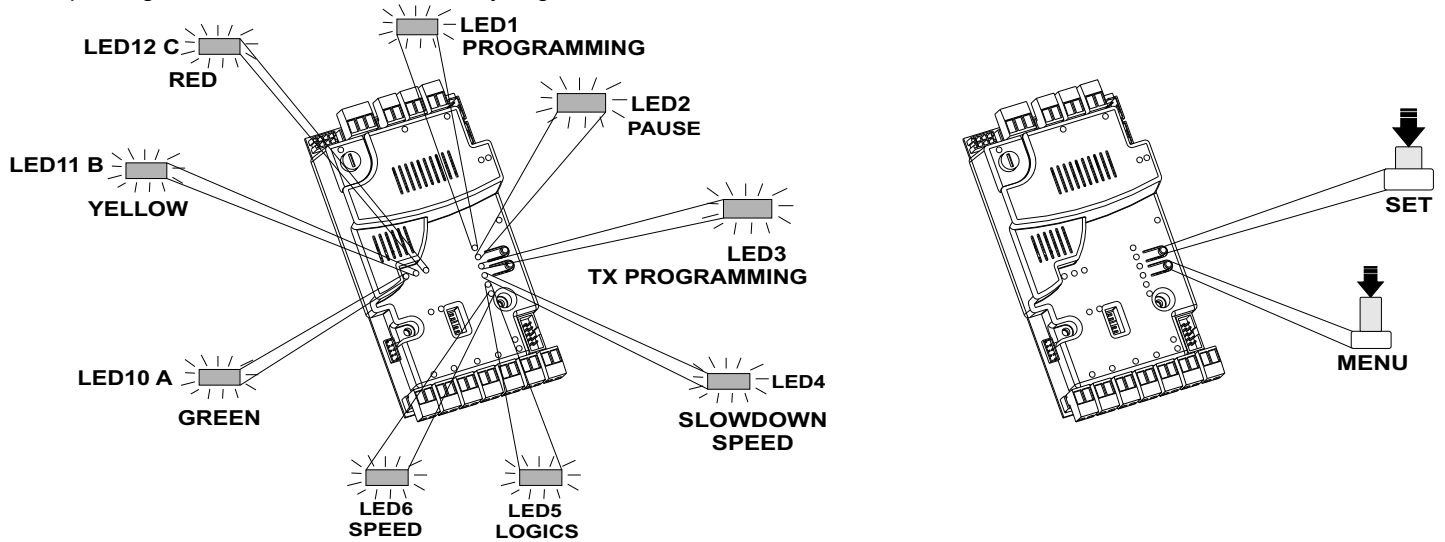

Selecting LED 2 with the "MENU" button you enter into pausing time regulation, with LED 2 turned on, hold pressed the selected button "SET" for the desired time of pause. According to the colour that the leds 10 A, 11 B and 12 C will assume it will be possible to have an order of the length of the set time of pause. If the button is released and pressed again the time of pause will be annulled.

- Led L10 A green turned on Time of pause <15 S.
- Led L11 B yellow turned on Time of pause <45 S.
- Led L12 C red turned on Time of break >45 S. up to 180 S.

JOLLY function: With the JOLLY programmer it is possible to adjust linearly this parameter without using the MENU and SET buttons.

Selecting LED 4 with the "MENU" button you enter into the slowdown speed adjustment, with LED 4 turned on, press the button "SET" till to select the desired leaf delay, observing the colours of the leds 10 A, 11 B and 12 C.

- Led L10 A green slowdown speed 30%
- Led L11 B yellow slowdown speed 35%
- Led L10 A - Led L11 B Green-yellow slowdown speed 45%
- Led L10 A - Led L12 C Green-red slowdown speed 50%

JOLLY function: With the JOLLY programmer it is possible to change this parameter without using the MENU and SET buttons.

Selecting LED 5 with the "MENU" button you enter into the choice of the functioning logics, with LED 5 turned on, press the button "SET" till to select the desired logic, observing the colours of the Leds 10 A, 11 B and 12 C.

- Led L10 A green on dead man logic
- Led L11 B yellow turned on automatic logic
- Led L12 C red turned on security logic
- Led L10 A green and L11 B yellow step by step type 1 logic
- Led L11 B yellow and L12 C red Step by step type 2 logic
- Led L10 A green and Led L12 C red switched on 2 pushbutton logic

JOLLY function: With the JOLLY programmer it is possible to select the logic without using the MENU and SET buttons on the control unit.

Selecting LED 5 with the "MENU" button you enter into the choice of the motors' speed, with LED 5 turned on, press the button "SET" till to select the desired speed, observing the colours of the leds 10 A, 11 B and 12 C.

- Led L10 A green turned on slow speed
- Led L11 B yellow turned on middle speed
- Led L12 C red turned on high speed
- Hold pressed "SET" for more then 5 seconds to annul the executed number of cycles

JOLLY function: With the JOLLY programmer it is possible to select the speed without using the MENU and SET buttons on the control unit.

Selecting LED 1 and LED 2 (with alternate flashing) with the "MENU" button you enter into the motor torque adjustment. With LED 1 and LED 2 flashing alternatively keep pressed the button "SET" while selecting the desired torque, observing the color of the LEDS 10 A, 11 B, 12 C.

- Led L10 A green turned on, torque = Low
- Led L11 B yellow turned on, torque = Middle
- Led L12 C red turned on, torque = Middle high
- Led L10 A, L11 B and L12 C turned on, torque = High

JOLLY function: With the Jolly programmer this parameter is adjustable linearly and differentiable for single opening direction without using the SET and MENU buttons on the control unit.

Selecting LED 5 and 6 (with alternate flashing) with the "MENU" button you enter into the choice of the type of motor that you are using.

Note: In default the control unit is set on sliding motor.

- Led L10 A green sliding
- Led L11 B yellow barrier
- Led L12 C red VERG
- Led L10 A green, Led L11 B yellow JOINT

JOLLY function: With the Jolly programmer it is possible to select the motor type without using the SET and MENU button on the control unit.

Selecting with the pusbutton "MENU" LEDs 3 and 4 with alternated flashing, you enter into the choice of setting the control unit as MASTER or as SLAVE.

- Led L10 A, L11 B, L12 C turned on MASTER
- Led L10 A, L11 B, L12 C turned off SLAVE

JOLLY function: with the Jolly programmer it is possible to select the card as MASTER or SLAVE without using the SET and MENU buttons on board of the card.

After 5 seconds without having pressed any button, the parameters' adjustment function will be automatically left.

If the control unit turns on when holding pressed the buttons "MENU" and "SET" contemporarily, the control unit will start with the DEFAULT parameter (see preceding page).



EXTERNAL RECEIVER

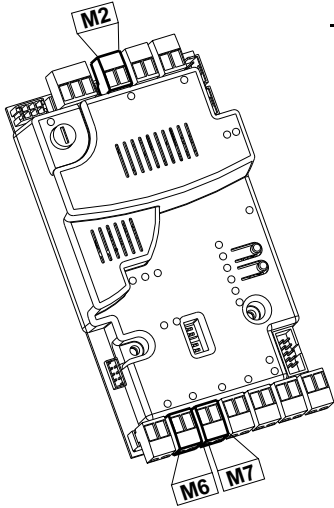

Example: Connection of a radio receiver

For the connection of the receiver refer to the relative instructions manual.

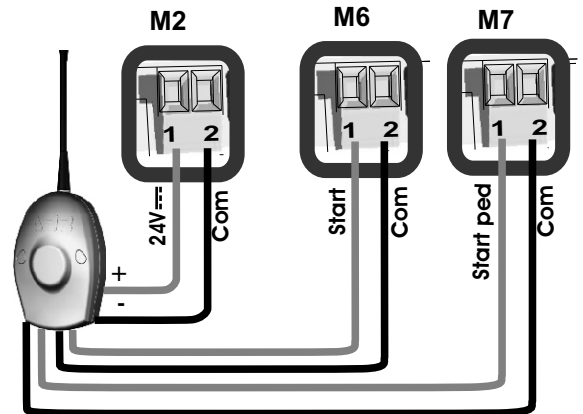

RADIO TRANSMITTER SELF LEARNING

WITH RECEIVER ON BOARD OF CONTROL UNIT

⚠ WARNING: Make the radio transmitters programming before you connect the antenna and insert the receiver into the special CMR connector (if available) with turned off control unit. (The control unit automatically recognizes if the receiver is a RF or RF Roll module)

Note: With a RF module it will be possible to use only 12 bit radio transmitters, that are Coccinella Dip and Copy and Smart Dual. With RF Roll module it will be possible to use only Coccinella Roll radio transmitters.

1. Select LED 3 with the MENU push button, at this point press the button "SET" and the LED 3 will flash together with the LED 10 A (green) to signal that it waits for a code to be associated to the total opening;
2. Press the desired button of the radio transmitter, the LED 10 A (green) will turn off to signal the memorisation of the data; now it returns to flash for 5 seconds waiting for other codes.
3. If it is desired to also associate a command to the pedestrian start, press **SET** again, the LED 11 B (yellow) will flash for signalling that it is waiting for a code to be associated to the **pedestrian opening**;
4. Press the desired button of the radio transmitter, LED 11 B will turn off to signal the memorisation of the data; now it will turn to flash waiting for other codes to be associated to the pedestrian start. If no other buttons are pressed within 5 seconds the programming will be left.
5. At this point it is possible to press the desired button of the radio transmitter and the LEDs 10 A, 11 B, 12 C (green, yellow, red) will show the available memory, LED 10 A (green) shows the occupied memory, less than 50%, LED 11 B (yellow) shows the occupied memory, more than 50%, LED 12 C (red) full memory.
6. To delete all memorized codes keep pressed for more than 5 seconds the adjusted button until the LEDs yellow B, red C and green A will flash contemporarily to confirm the cancellation.



JOLLY functions: It is possible to monitor the state of occupation of the of the radio transmitter memory.

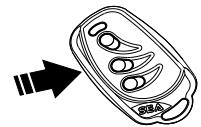
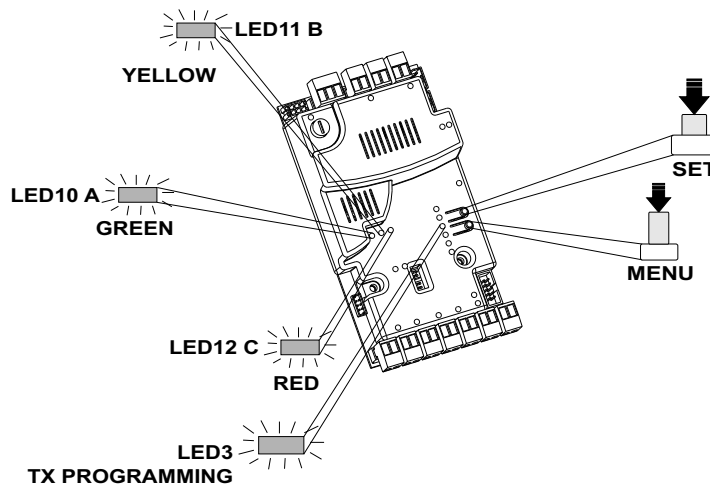

Notes:

- Enter radio transmitters learning only when the working cycle stops and the gate is closed.
- It's possible to memorize up to 800 codes (buttons).
- If all available codes have already been memorized and you try to memorize a further code, the led 12 C (red) will flash for signalling the error.
- If the board receives a code which was already associated to another function it will be updated with the new function.



FUNCTION LOGIC

AUTOMATIC LOGIC

A start impulse opens the gate. A second impulse during the opening will not be accepted.
A start impulse during closing reverses the movement.
To activate the automatic re-closing put DIP1 and DIP4 on ON.
With DIP2 and DIP4 on ON start in pause is activated

SECURITY LOGIC

A start impulse opens the gate. A second impulse during opening reverses the movement.
A start impulse during closing reverses the movement.
To activate the automatic re-closing put DIP1 and DIP4 on ON.
With DIP2 and DIP4 on ON start in pause is activated.

STEP BY STEP TYPE 1 LOGIC

The start impulse follows the OPEN-STOP-CLOSE-STOP-OPEN logic.
To activate the automatic re-closing put DIP1 on ON.
With DIP2 it is possible to choose whether to make accept the start in pause or not.

STEP BY STEP TYPE 2 LOGIC

The start impulse follows the OPEN-STOP-CLOSE-OPEN logic.
To activate the automatic re-closing put DIP1 on ON.
With DIP2 it is possible to choose whether to make accept the start in pause or not.

DEAD MAN LOGIC

The gate opens as long as the **START** button of opening is pressed; releasing it the gate stops. The gate closes as long as the button connected to the **PEDESTRIAN START** is pressed; releasing it the gate stops. To execute complete opening and/or closing cycles the related pushbuttons must be constantly pressed.

2 PUSHBUTTONS LOGIC

One start opens, one pedestrian start closes. In opening the closing will not be accepted. In closing a start command reopens, a pedestrian start command (closes) will be ignored.



Jolly option:

If you dispose of a Jolly programmer it is possible to activate the automatic reclosing and the start in pause from the programmer without accessing the control unit.

JOLLY function: With the JOLLY programmer it is possible to select the logic without using the SET and MENU buttons on the control unit.

DESCRIPTION OF THE BUS SYSTEM

The BUS is a connecting system through which it is possible to connect different accessories among which: photocells, key switches, warning lamps, numerical keyboards and key selectors, all in parallel on the same entry and all through two only threads. This system therefore allows to eliminate the two threads of the power supply for the accessories, therefore every accessory will be equipped with only two threads. Every accessory is equipped with a rotating changer, which allows to join the various devices according to a numerical sequence which defines the particular function assigned to that accessory.

Photocells' alignment

If photocells are connected on the BUS it is necessary to line up the same before programming. To do the alignment it is necessary to start a self-learning cycle of the times. At this point, the gate will stand still, as long as the photocells are not lined up. Once the photocells have been lined up, push the SET button to restart the self-learning of the times.

Photocells BUS addressing

Rotating Changer on TX and RX on 0 or 1 = photocell active only in opening Rotating Changer on TX and RX on 2 or 3 = photocell active only in closing Rotating changer on TX and RX on 4 = photocell both in opening and in closing.

The positions from 6 to 9 are interpreted as active photocells both in closing and in opening.

Note: Two couples of photocells with the same function have to have a different number. For ex. on two couples in closing TX and RX of the first one will have the number 2, TX and RX of the second couple will have the number 3.

Initialization BUS

Connect all the devices in parallel on the clamp M11 or in parallel between them.

At the lighting of the control unit make sure that the LED13 (red) performs some fast flashes, at this point, if the red led remains turned on this means that there is an error on the BUS, signalled from the display or by 8 flashes on the warning lamp, but if the red led will keep on flashing slowly the BUS is perfectly working.

NOTE: To repeat the search of the peripheral BUS in case of BUS error, press contemporarily the buttons + and - of the display, or press the button until LED 11 B turns on. At this point keep pressed SET as long as LED 11 B does not turn off and LED 10 A turns on.

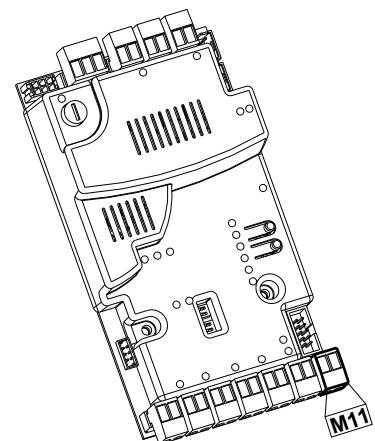
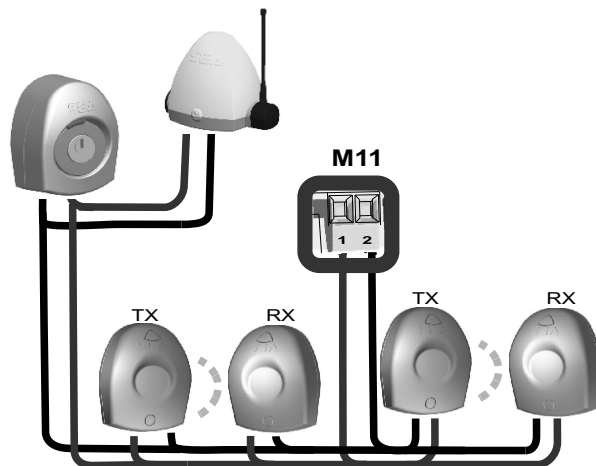



MASTER-SLAVE FUNCTION

MASTER

SLAVE

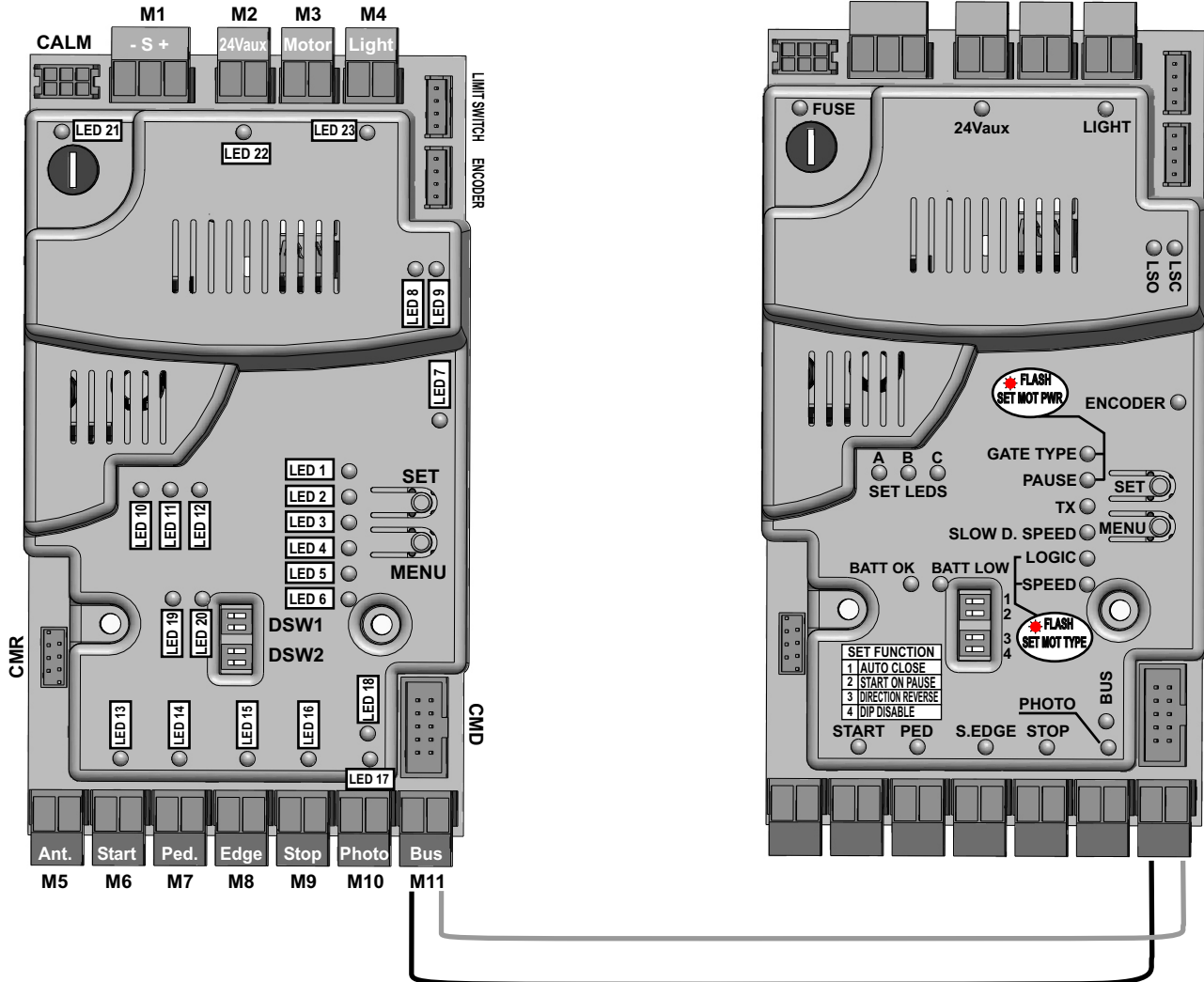

To set an installation with two motors in **MASTER-SLAVE** function it is recommended to do as follows:

- 1) Set the two motors as if they were two independent installations, make sure that the individual motor works properly and that the limit switches (when present) are read properly.
- 2) Once sure of the correct functioning connect the control unit MASTER to the control unit SLAVE through the BUS with two cables paying especially attention to keep the polarity of the cables.
- 3) Now set the control unit, which has to manage the commands and motor 1 (photocell, keyswitch, STOP, safety edge etc.) as MASTER and the other one which will move motor 2 as SLAVE.

To set the MASTER, scroll through the menu until you have found the two central LEDs (TX and SLOW DOWN SPEED) so that the LEDs blink alternately, and set the SET led (10 A, 11 B and 12 C) so that all three leds are off. Execute the same operation on the SLAVE control unit, setting the SET led (10 A, 11 B and 12 C) so that all three leds stay on. If you have a PALM USER (JOLLY) it is sufficient to choose MASTER or SLAVE in the functions list.

4) Now search the BUS devices as described in the note on the preceding page.

5) Follow up the selflearning of the times of the MASTER control unit.

Note 1: All these operations can also be managed through the PALM USER (JOLLY).

Note 2: On the SLAVE it is possible to set the following functions only: torque, speed, motor type, slowdown speed, acceleration, deceleration, position recovery, 24V aux and motor inversion. All other parameters will be set only by the MASTER control unit.



PROGRAMMER JOLLY PARAMETERS ADJUSTMENT

The JOLLY programmer allows to keep under control and to change all parameters of the control unit without need to use the SET and MENU buttons of the control unit. Furthermore, it is essential for the initial setting of some parameters which are not settable directly on the control unit which are: selftest photocell, photocell in opening, anti-intrusion, separate regulation of the motor torque in opening and closing, slow-down speed, learning speed, acceleration, deceleration, leaf stroke, number of cycles, pedestrian opening, foto/timer, ped/Timer, 24Vaux, control lamp, balanced edge, closing with photocell.

Note: Through the JOLLY programmer it is also possible to start the selflearning of the working times.

Screen 1	
Language: Italian	With buttons + and - it is possible to modify the language ←

← The arrow shows that the parameter is modifiable with the buttons + and -

Screen 2	
Cycle	Automat./Secur./Step by step1/Step by step2/Dead man/ 2 boutons ←
Encoder	on/off (function with encoder, not implemented) ←
Time of pause	[0÷120]s (time of pause in seconds) ←

→ Shows the working logic adjusted on board of the control unit.

Screen 3	
Learning	on alignment/off (signalling of the execution of the learning) ←
Modality	Master/Slave ←
Cicli exec.	[0÷2 ³²] (number of executed cycles)
Mem. free	[0÷100]% (percentage of available memory for the learning of remote controls)

Note: The alignment appears only if photocells are present on the BUS.

Screen 4	
Motor	(Sliding) (Barrier) (Joint) ←
Speed	[30÷100] adjusts the motors' speed ←
Sl. speed	[30÷100] adjusts the slow down speed ←
Lear. Speed.	[30÷100] adjusts the learning speed ←

→ Indicates the type of motor set

Screen 5	
Photocell Tx1	[OK-NP] (peripheral reveal - not present)
Photocell Tx2	[OK-NP] (peripheral reveal - not present)
Photocell TX3	[OK-NP] (peripheral reveal - not present)

The screens 4, 5, 6, 7, 8 and 9 show the type of accessory on the BUS.

Screen 6	
Photocell TX4	[OK-NP] (peripheral reveal - not present)
Photocell TX5	[OK-NP] (peripheral reveal - not present)

Screen 7	
Photocell Rx1	[OK-NP] (peripheral reveal - not present)
Photocell RX2	[OK-NP] (peripheral reveal - not present)
Photocell Rx3	[OK-NP] (peripheral reveal - not present)

Screen 8	
Photocell RX4	[OK-NP] (peripheral reveal - not present)
Photocell RX5	[OK-NP] (peripheral reveal - not present)

Screen 9	
Interface relay	[OK-NP] (peripheral reveal - not present)
Flashing lamp	[OK-NP] (peripheral reveal - not present)
Slave	[OK-NP] (peripheral reveal - not present)



PROGRAMMER JOLLY PARAMETERS ADJUSTMENT

NOTE: For the respect of the valid European rules on the safety of the electric gates, it is recommended to not adjust the parameters **torque Max 1** and **torque Max 2** on the value 100%.

Screen 10		
Accelerat.	[0÷100]% (inclination of the ramp of acceleration)	←
Decelerat.	[0÷100]% (inclination of the ramp of acceleration)	←
Pedestrian op.	[30,50,100]% (percentage pedestrian opening)	←

It allows to regulate the duration of the acceleration of the motors on the start. If on 100% the gate will immediately depart at the max. adjusted speed.

It allows to regulate the duration of the deceleration of the motor at the end of opening and closing. If on 0% the gate won't effect the phase of deceleration.

Screen 11		
Torque op. M1	[10÷100]% (max. current of the motors)	←
Torque clo. M1	[10÷100]% (max. current of the motors)	←

Allows to regulate and to visualize the sensitivity of the anti-squeezing for single opening direction. With value 100% the gate in presence of obstacle will reverse the movement after 5 seconds.

Screen 12		
Anti-intrusion	on/off (in ON it implicates the presence of a contact N.C. On the limit switch that, if freed, forces the motors in closing)	←
Pre-flashing	on/off (activation of the pre-flashing)	←
Autotest photo.	on/off (activates autotest photocell)	←
Max cycle	0÷100000 (indicates the number of cycles after which it is necessary to follow up the maintenance)	←

Normal:
1 Flash/s in opening
2 Flash/s in closing
On in pause

Control lamp: the alarm signals remain until they are eliminated

Continuous: flashes always also when gate is not in movement

Screen 13		
Warning lamp	Normal/Control/Continuous	←
Foto	closing/opening/stop/park/close immediately	←
Reverse stroke	on/off (Disabled)	←
Posit. recover	0% 100%	←

For the functions Fotoopen, Fotostop, Fotopark, see page 22.

Screen 14		
Photo/Timer	ON/OFF On ON the PHOTO entry becomes TIMER	←
Ped/Timer	ON/OFF On ON the PED entry becomes TIMER	←
Clos. Photo	ON/OFF On ON if the photocell is occupied the gate recloses interrupting the pause	←
Balanced edge	on/off (In ON it is necessary to insert in series to the edge contact a 8K2 Ohm resistance)	←

Allows to optimize the point of slowdown beginning in case of inversion of the motion and in function of the weight of the gate

Screen 15		
24V aux	During cycle/in opening/in closing/in Pause/Always	←
Autom. clos.	ON/OFF If on ON at the end of the set pause the gate re-closes automatically	←
Start on pause	ON/OFF If on ON with autom. Clos. on ON a start impulse provokes the immediate re-closing of the autom.	←
Mot. rev.	ON/OFF Allows to exchange contemporarily the limit switch and the motor rotation direction without disconnecting the wires	←

Allows to decide when having power supplied the exit 24V Aux.

Note: After this operation it is necessary to switch off the power supply of the motors and to repeat the selflearning of the times. If the motor is not synchronized with the limit switch, during selflearning the automation stops on the first limit switch it recognizes without completing the selflearning of the times. In that case it will be necessary to switch off the power supply again, to manually exchange the wires of the motor and to repeat the selflearning.

Screen 16		
List of events	Shows the last 10 events on the control unit	
N°10		←
N°9		
N°8		

Diagnostic 10 last events



CONNECTION OF BATTERIES TO BATTERY CHARGER CARD

Battery signals:

- *Batteries loaded up to 20V:*
green led turned on, red led turned off.

- *Batteries with tension between 20 and 18V:*
green led flashes, red led is off ; in absence of net the flashing lamp signals that the battery is unloaded sending flashes with less frequency.

- *Unloaded batteries <18V:*
green led off, red led turned on fix. In absence of net the cycle will be stopped and the flashing lamp will send 10 flashes.

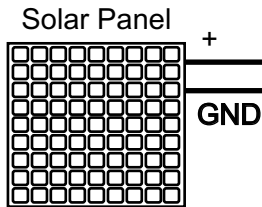

Cod.23101110

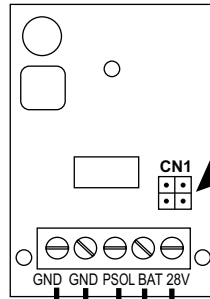

28V --- Battery charger (BAT)
+ Positive battery
- Negative battery charger



- = charge 200mA
- = charge 360mA
- = charge 800mA

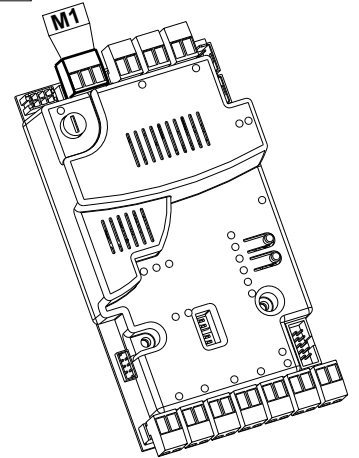

USER24

Battery current (mA)	Battery (Ah)
800	12 or 16
360	7
200	2

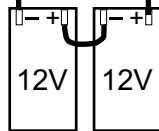

Batteries

Insert two 12V batteries connected in series.

ALARMS INDICATIONS

The flashing sequence is signalled at every opening and closing of the automation on the warning lamp. The warning lamp will send a flashing every second in opening and two flashings in closing, while it will remain turned on fixed in pause.

Flashings Number	Kind of alarm
2	Photocell
3	Photocell in opening
4	Safety edge
5	Stop

Flashings Number	Kind of alarm
6	Collision on obstacle
7	Reached maximum cycles
8	Alarm BUS
9	Motor failure
10	Alarm battery unloaded

ALARM SIGNALS

The damages with 2,3, 4 and 5 flashings, refer to normally closed contacts, therefore verify if such are the connections and/or the correct working of the photocells, of the Stop button and/or of the safety edge.

2. The failure with 6 flashes refers to a collision with an obstacle which has been revealed by the ammeter sensor, therefore it is necessary either to replace the motor or to verify the conditions of the connections.

3. Periodically, in relation to the number of manoeuvre and the type of gate, it is recommended to execute, if the gate has modified the attritions and it doesn't work, **the re-programming of the times of learning on the electronic board.**

The damage with 7 flashes refers to the attainment of the established maximum cycles for the maintenance of the control unit, therefore it is necessary to perform the maintenance and to put on zero the number of cycles, according to the following procedure: Through the button **SEL** select the **LED 6 of the motor's speed**, keep pressed the chosen button for more than 5 seconds.

4. The damage with 8 flashes indicates a generic error on the BUS, this means that there is a short circuit on one of the connected devices to the BUS, and it is necessary to verify the connections and the functionality of the connected devices or the connected devices are not correctly connected between them (see paragraph on the BUS management)

5. The damage with 9 flashes refers to the exceeding of the max. shreshold of suppliable current from the central, therefore it is necessary to make sure that there is no short cut on the devices (f.ex. On the motor)



TROUBLE SHOOTING

Advises

Make sure all Safety LED are turned ON

All not-used N.C. contacts must have jumpers

Problem Found	Possibile Cause	Solutions
Motor doesn't respond to any START impulse	a.) Jumper missing on one of the N.C. Contacts b.) Burnt fuse	a.) Check the connections or the jumpers on the connections of the safety edge, of the stop and of the photocell b.) Replace the burned fuse on the control unit led 1 turned on.
Gate doesn't move while the motor is running	a.) The motor is in the released position b.) There is an obstacle	a.) Re-lock the motor b.) Remove obstacle
Gate doesn't reach the complete Open / Closed position	a.) Wrong setting of the limit switches b.) Error on programming c.) Gate is stopped by an obstacle d.) Torque or speed too low	a.) Set limit switches b.) Repeat programming c.) Remove obstacle d.) Increase torque parameter
The gate opens but doesn't close	a.) The photocell contacts are not closed b.) Ammeter alarm	a.) Check the LED or the jumpers or the signals indicated on the warning lamp b.) Check if the ammeter alarm has intervened and eventually increase the torque parameter.
The gate doesn't close automatically	a.) Pause time set to high b.) Control unit in semi-autom. logic	a.) Adjust pause time b.) Set DIP1 on ON or set "autom. closing" on the JOLLY programmer on ON.

Page for both instaler and user

MAINTENANCE

Considering the number of working cycles and the kind of gate, if the gate has changed the clutches and doesn't work it's necessary to periodically proceed, with **the learning times reprogramming on the electronic control unit**.
Periodically clean the optical systems of the photocells.

REPLACEMENTS

Any request for spare parts must be sent to:

SEA s.r.l. - Zona Ind.le, 64020 S.ATTO - Teramo - Italia

SAFETY AND ENVIRONMENTAL COMPATIBILITY

Disposal of the packaging materials of products and/or circuits should take place in an approved disposal facility.



REGULAR PRODUCT DISPOSAL (electric and electronic waste)

(It's applicable in EU countries and in those ones provided with a differential waste collection)

The brand that you find on the product or on documentation signals that the product must not be disposed off together with other domestic waste at the end of life cycle. In order to avoid any possible environmental or health damage caused by irregular waste disposal, we recommend to separate this product from other forms of waste and to recycle it in a responsible way in order to provide the sustainable re-use of material resources. Domestic users are invited to contact the retailer where the product has been purchased or the local office in charge of all the information related to differential waste collection and recycling of this kind of product.

STORING

WAREHOUSING TEMPERATURES			
T_{min}	T_{Max}	Dampness_{min}	Dampness_{Max}
- 20°C	+ 65°C	5% <i>Not condensing</i>	90% <i>Not condensing</i>

Materials handling must be made with appropriate vehicles..

WARRANTY LIMITS

For the guarantee see the sales conditions on the official SEA price list.

SEA reserves the right to make any required modification or change to the products and/or to this manual without any advanced notice obligation.



CONDIZIONI DI VENDITA

EFFICACIA DELLE PRESENTI CONDIZIONI GENERALI DI VENDITA: Le presenti condizioni generali di vendita si applicano a tutti gli ordini indirizzati a SEA s.r.l. Tutte le vendite fatte da SEA ai clienti sono regolate secondo le presenti condizioni di vendita che costituiscono parte integrante del contratto di vendita ed annullano ogni clausola contraria o pattuizioni particolari presenti nell'ordine o in altro documento proveniente dall'acquirente (cliente)

AVVERTENZE GENERALI Gli impianti di automazioni porte e cancelli vanno realizzati esclusivamente con componenti SEA, salvo accordi specifici. L'inosservanza delle norme di sicurezza vigenti (Norm. EUROPEE EN 12453 - EN 12445 e altro) e di buona tecnica esclude la SEA da ogni responsabilità. La SEA non risponde del mancato rispetto della corretta e sicura installazione secondo le norme.

1) PROPOSTA D'ORDINE La proposta d'ordine si intenderà accettata solo dopo la sua approvazione da parte della SEA. Conseguenza della sua sottoscrizione, l'acquirente sarà vincolato alla stipula di un contratto d'acquisto, secondo quanto contenuto nella stessa proposta d'ordine e nelle presenti condizioni di vendita. Viceversa, la mancata comunicazione all'acquirente dell'approvazione della proposta d'ordine, non comporta la sua automatica accettazione da parte della SEA

2) VALIDITÀ OFFERTA Le offerte proposte dalla SEA o dalla sua struttura commerciale periferica, avranno una validità di 30 giorni solari, salvo diversa comunicazione in merito.

3) PREZZI I prezzi della proposta d'ordine sono quelli del listino in vigore alla data della redazione della stessa. Gli sconti applicati dalla struttura commerciale periferica della SEA si intenderanno validi solo dopo la loro accettazione da parte della SEA. I prezzi si intendono per merce resa franco ns. stabilimento in Teramo, esclusi IVA ed imballaggi speciali. La SEA si riserva il diritto di modificare in qualsiasi momento il listino, dando opportuno preavviso alla rete di vendita. Le condizioni speciali riservate agli acquisti con formula agevolata Qx, Qx1, Qx2, Qx3 sono riservate ai distributori ufficiali dietro accettazione scritta da parte della direzione SEA.

4) PAGAMENTI Le forme di pagamento ammesse sono quelle comunicate o accettate di volta in volta dalla SEA. Il tasso di interesse sul ritardo da pagamento è del 1,5% mensile e comunque non oltre il tasso massimo legalmente consentito.

5) CONSEGNA La consegna avverrà indicativamente ma non tassativamente entro 30 giorni lavorativi dalla data di ricezione dell'ordine, salvo diverse comunicazioni in merito. Il trasporto degli articoli venduti sarà effettuato a spese ed a rischio dell'acquirente. La SEA si libera dall'obbligo della consegna rimettendo la merce al vettore, sia esso scelto dalla SEA oppure dall'acquirente. Eventuali smarrimenti e/o danneggiamenti della merce dovuti al trasporto, sono a carico dell'acquirente.

6) RECLAMI Eventuali reclami e/o contestazioni dovranno pervenire alla SEA entro 8 giorni solari dalla ricezione della merce, supportati da idonei documenti provanti la loro veridicità.

7) FORNITURA L'ordine in oggetto viene assunto da SEA senza alcun impegno e subordinatamente alle possibilità di approvvigionamento delle materie prime occorrenti alla produzione; eventuali mancate esecuzioni totali o parziali non possono dar luogo a reclami e riserve per danni. La fornitura SEA è strettamente limitata alla sola merce di sua produzione, esclusi il montaggio, l'installazione ed il collaudo. La SEA declina pertanto ogni responsabilità per danni che dovessero derivare, anche a terzi, dall'inosservanza delle norme di sicurezza e della buona regola d'arte nelle fasi dell'installazione e dell'impiego dei prodotti venduti.

8) GARANZIA La garanzia minima è di 12 mesi e può essere estesa, come di seguito, in caso di riconsegna del certificato di garanzia.

SILVER: Le parti meccaniche degli operatori rientranti in tale categoria sono garantite per 24 mesi dalla data di fabbricazione riportata sull'operatore.

GOLD: Le parti meccaniche degli operatori rientranti in tale categoria sono garantite per 36 mesi dalla data di fabbricazione riportata sull'operatore.

PLATINUM: Le parti meccaniche degli operatori rientranti in tale categoria sono garantite per 36 mesi dalla data di fabbricazione riportata sull'operatore. La garanzia di base (36 mesi) sarà estesa per ulteriori 24 mesi (fino ad un totale di 60 mesi) qualora venga acquistato il certificato di garanzie che dovrà essere compilato e rispedito alla SEA s.r.l. entro 60 giorni dall'acquisto. L'elettronica e le centrali di comando sono garantite per 24 mesi dalla data di fabbricazione. Nell'eventualità di difettosità del prodotto, la SEA si impegna alla sua sostituzione gratuita oppure alla sua riparazione, previa restituzione al proprio centro di riparazione. La definizione di stato di garanzia è ad insindacabile giudizio della SEA. I pezzi sostitutivi restano di proprietà della SEA. In modo vincolante, il materiale dell'acquirente ritenuto in garanzia deve essere spedito al centro di riparazione della SEA in porto franco e sarà rispedito dalla SEA in porto assegnato. La garanzia non si estende alla manodopera eventualmente accorsa. I difetti riconosciuti non produrranno alcuna responsabilità e/o richiesta di danni, di qualsiasi natura essi siano, da parte dell'acquirente nei riguardi della SEA. La garanzia non è in ogni caso riconosciuta qualora sia stata apportata alla merce qualsivoglia modifica, oppure vi sia stato un uso improprio, oppure si sia in presenza di una qualsivoglia sua manomissione o di un montaggio non corretto, oppure se sia stata rimossa l'etichetta apposta dal produttore comprensiva del marchio SEA registrato n° 804888. La garanzia non è inoltre valida nel caso la merce SEA sia stata in parte o in toto accoppiata a componenti meccanici e/o elettronici non originali, ed in particolare in assenza di una specifica autorizzazione in merito, ed inoltre nel caso in cui l'acquirente non sia in regola con i pagamenti. La garanzia non comprende danni derivati dal trasporto, materiale di consumo, avarie dovute al mancato rispetto delle specifiche prestazionali dei prodotti indicate nel listino. Non è riconosciuto alcun indennizzo durante il tempo di riparazione e/o sostituzione della merce in garanzia. La SEA declina ogni responsabilità per danni a cose o persone derivanti dall'inosservanza delle norme di sicurezza e della non conforme installazione o dall'impiego errato dei prodotti venduti. La riparazione dei prodotti in garanzia e fuori garanzia è subordinata al rispetto delle procedure comunicate da SEA.

9) RISERVATO DOMINIO Sulla merce venduta è valida la clausola del riservato dominio, della quale la SEA deciderà autonomamente se avvalersi o meno, in virtù della quale l'acquirente acquisisce la proprietà della merce, solo dopo che il suo pagamento sia stato completamente effettuato.

10) FORO COMPETENTE Per qualsiasi controversia avente per oggetto l'applicazione di questo contratto, viene eletto competente il Foro di Teramo. La lingua valida nell'interpretazione di cataloghi, manuali di installazione, condizioni di vendita o altro è quella italiana. La SEA si riserva la facoltà di apportare modifiche tecniche atte a migliorare i propri prodotti, presenti o meno in questo Listino, in qualsiasi momento senza preavviso. La SEA declina ogni responsabilità derivante da possibili inesattezze contenute nel presente listino, derivanti da errori di stampa e/o trascrizione. Il presente Listino annulla e sostituisce quelli precedenti. L'acquirente ai sensi della legge 196/2003 (codice privacy) acconsente all'inserimento dei propri dati personali derivanti dal presente contratto negli archivi informatici e cartacei della SEA s.r.l. al loro trattamento per motivi commerciali ed amministrativi.

Diritti di proprietà industriale: il cliente, con l'acquisto, accetta le presenti condizioni di vendita e riconosce in capo a SEA la titolarità esclusiva del marchio internazionale SEA registrato n. 804888 apposto sulle etichette dei prodotti e/o sui manuali e/o su ogni altra documentazione, e si impegna ad utilizzare il medesimo nella propria attività di rivendita e/o installazione secondo modalità che non ne riducano in alcun modo i diritti, a non rimuovere, sostituire o alterare marchi o altri segni distintivi di qualsiasi genere apposti ai prodotti.

E' vietata ogni forma di riproduzione o utilizzo del marchio SEA e di ogni altro segno distintivo presente sui prodotti, salvo autorizzazione scritta di SEA srl.

Agli effetti dell'articolo 1341 del C.C. si approvano specificatamente per iscritto le clausole di cui ai numeri:

4) PAGAMENTI - 8) GARANZIA - 10) FORO COMPETENTE



TERMS OF SALES

EFFICACY OF THE FOLLOWING TERMS OF SALE: the following general terms of sale shall be applied to all orders sent to SEA srl. All sales made by SEA to all costumers are made under the prescription of this terms of sales which are integral part of sale contract and cancel and substitute all apposed clauses or specific negotiations present in order document received from the buyer.

GENERAL NOTICE The systems must be assembled exclusively with SEA components, unless specific agreements apply. Non-compliance with the applicable safety standards (European Standards EM12453 – EM 12445) and with good installation practice releases SEA from any responsibilities. SEA shall not be held responsible for any failure to execute a correct and safe installation under the above mentioned standards.

1) PROPOSED ORDER The proposed order shall be accepted only prior SEA approval of it. By signing the proposed order, the Buyer shall be bound to enter a purchase agreement, according to the specifications stated in the proposed order.

On the other hand, failure to notify the Buyer of said approval must not be construed as automatic acceptance on the part of SEA.

2) PERIOD OF THE OFFER The offer proposed by SEA or by its branch sales department shall be valid for 30 solar days, unless otherwise notified.

3) PRICING The prices in the proposed order are quoted from the Price List which is valid on the date the order was issued. The discounts granted by the branch sales department of SEA shall apply only prior to acceptance on the part of SEA. The prices are for merchandise delivered ex-works from the SEA establishment in Teramo, not including VAT and special packaging. SEA reserves the right to change at any time this price list, providing timely notice to the sales network. The special sales conditions with extra discount on quantity basis (Qx, Qx1, Qx2, Qx3 formula) is reserved to official distributors under SEA management written agreement.

4) PAYMENTS The accepted forms of payment are each time notified or approved by SEA. The interest rate on delay in payment shall be 1.5% every month but anyway shall not be higher than the max. interest rate legally permitted.

5) DELIVERY Delivery shall take place, approximately and not peremptorily, within 30 working days from the date of receipt of the order, unless otherwise notified. Transport of the goods sold shall be at Buyer's cost and risk. SEA shall not bear the costs of delivery giving the goods to the carrier, as chosen either by SEA or by the Buyer. Any loss and/or damage of the goods during transport, are at Buyer's cost.

6) COMPLAINTS Any complaints and/or claims shall be sent to SEA within 8 solar days from receipt of the goods, proved by adequate supporting documents as to their truthfulness.

7) SUPPLY The concerning order will be accepted by SEA without any engagement and subordinately to the possibility to get it's supplies of raw material which is necessary for the production; Eventual completely or partially unsuccessful executions cannot be reason for complains or reservations for damage. SEA supply is strictly limited to the goods of its manufacturing, not including assembly, installation and testing. SEA, therefore, disclaims any responsibility for damage deriving, also to third parties, from non-compliance of safety standards and good practice during installation and use of the purchased products.

8) WARRANTY The standard warranty period is 12 months. This warranty time can be extended by means of expedition of the warranty coupon as follows:

SILVER: The mechanical components of the operators belonging to this line are guaranteed for 24 months from the date of manufacturing written on the operator.

GOLD: The mechanical components of the operators belonging to this line are guaranteed for 36 months from the date of manufacturing written on the operator.

PLATINUM: The mechanical components of the operators belonging to this line are guaranteed for 36 months from the date of manufacturing written on the operator. The base warranty (36 months) will be extended for further 24 months (up to a total of 60 months) when it is acquired the certificate of warranty which will be filled in and sent to SEA s.r.l. The electronic devices and the systems of command are guaranteed for 24 months from the date of manufacturing. In case of defective product, SEA undertakes to replace free of charge or to repair the goods provided that they are returned to SEA repair centre. The definition of warranty status is by unquestionable assessment of SEA. The replaced parts shall remain propriety of SEA. Binding upon the parties, the material held in warranty by the Buyer, must be sent back to SEA repair centre with fees prepaid, and shall be dispatched by SEA with carriage forward. The warranty shall not cover any required labour activities.

The recognized defects, whatever their nature, shall not produce any responsibility and/or damage claim on the part of the Buyer against SEA. The guarantee is in no case recognized if changes are made to the goods, or in the case of improper use, or in the case of tampering or improper assembly. Furthermore, the warranty shall not apply if SEA products are partly or completely coupled with non-original mechanical and/or electronic components, and in particular, without a specific relevant authorization, and if the Buyer is not making regular payments. The warranty shall not cover damage caused by transport, expendable material, faults due to non-conformity with performance specifications of the products shown in the price list. No indemnification is granted during repairing and/or replacing of the goods in warranty. SEA disclaims any responsibility for damage to objects and persons deriving from non-compliance with safety standards, installation instructions or use of sold goods.

9) RESERVED DOMAIN A clause of reserved domain applies to the sold goods; SEA shall decide autonomously whether to make use of it or not, whereby the Buyer purchases propriety of the goods only after full payment of the latter.

10) COMPETENT COURT OF LAW In case of disputes arising from the application of the agreement, the competent court of law is the tribunal of Teramo. SEA reserves the faculty to make technical changes to improve its own products, which are not in this price list at any moment and without notice. SEA declines any responsibility due to possible mistakes contained inside the present price list caused by printing and/or copying. The present price list cancels and substitutes the previous ones. The Buyer, according to the law No. 196/2003 (privacy code) consents to put his personal data, deriving from the present contract, in SEA archives and electronic files, and he also gives his consent to their treatment for commercial and administrative purposes. Industrial ownership rights: once the Buyer has recognized that SEA has the exclusive legal ownership of the registered SEA brand, he will commit himself to use it in a way which does not reduce the value of these rights, he won't also remove, replace or modify brands or any other particularity from the products. Any kind of replication or use of SEA brand is forbidden as well as of any particularity on the products, unless preventive and expressed authorization by SEA.

In accomplishment with art. 1341 of the Italian Civil Law it will be approved expressively clauses under numbers:

4) PAYMENTS - 8) GUARANTEE - 10) COMPETENT COURT OF LAW



Italiano AVVERTENZE GENERALI PER INSTALLATORE E UTENTE

1. Leggere attentamente le **Istruzioni di Montaggio** e le **Avvertenze Generali** prima di iniziare l'installazione del prodotto. Conservare la documentazione per consultazioni future
2. Non disperdere nell'ambiente i materiali di imballaggio del prodotto e/o circuiti
3. Questo prodotto è stato progettato e costruito esclusivamente per l'utilizzo indicato in questa documentazione. Qualsiasi altro utilizzo non espressamente indicato potrebbe pregiudicare l'integrità del prodotto e/o rappresentare fonte di pericolo. L'uso improprio è anche causa di cessazione della garanzia. La SEA srl declina qualsiasi responsabilità derivata dall'uso improprio o diverso da quello per cui l'automatismo è destinato.
4. I prodotti SEA sono conformi alle Direttive: Macchine (2006/42/CE e successive modifiche), Bassa Tensione (2006/95/CE e successive modifiche), Compatibilità Elettromagnetica (2004/108/CE e successive modifiche). L'installazione deve essere effettuata nell'osservanza delle norme EN 12453 e EN 12445.
5. Non installare l'apparecchio in atmosfera esplosiva.
6. SEA srl non è responsabile dell'inosservanza della Buona Tecnica nella costruzione delle chiusure da motorizzare, nonché delle deformazioni che dovessero verificarsi durante l'uso.
7. Prima di effettuare qualsiasi intervento sull'impianto, togliere l'alimentazione elettrica e scollegare le batterie. Verificare che l'impianto di terra sia realizzato a regola d'arte e collegarvi le parti metalliche della chiusura.
8. Per ogni impianto SEA srl consiglia l'utilizzo di almeno una segnalazione luminosa nonché di un cartello di segnalazione fissato adeguatamente sulla struttura dell'infisso.
9. SEA srl declina ogni responsabilità ai fini della sicurezza e del buon funzionamento della automazione, in caso vengano utilizzati componenti di altri produttori.
10. Per la manutenzione utilizzare esclusivamente parti originali SEA.
11. Non eseguire alcuna modifica sui componenti dell'automazione.
12. L'installatore deve fornire tutte le informazioni relative al funzionamento manuale del sistema in caso di emergenza e consegnare all'Utente utilizzatore dell'impianto il libretto d'avvertenze allegato al prodotto.
13. Non permettere ai bambini o persone di sostare nelle vicinanze del prodotto durante il funzionamento. L'applicazione non può essere utilizzata da bambini, da persone con ridotte capacità fisiche, mentali, sensoriali o da persone prive di esperienza o del necessario addestramento. Tenere inoltre fuori dalla portata dei bambini radiocomandi o qualsiasi altro datore di impulso, per evitare che l'automazione possa essere azionata involontariamente.
14. Il transito tra le ante deve avvenire solo a cancello completamente aperto.
15. Tutti gli interventi di manutenzione, riparazione o verifiche periodiche devono essere eseguiti da personale professionalmente qualificato. L'utente deve astenersi da qualsiasi tentativo di riparazione o d'intervento e deve rivolgersi esclusivamente a personale qualificato SEA. L'utente può eseguire solo la manovra manuale.
16. La lunghezza massima dei cavi di alimentazione fra centrale e motori non deve essere superiore a 10 m. Utilizzare cavi con sezione 2.5 mm². Utilizzare cablaggi con cavi in doppio isolamento (cavi con guaina) nelle immediate vicinanze dei morsetti specie per il cavo di alimentazione (230V). Inoltre è necessario mantenere adeguatamente lontani (almeno 2.5 mm in aria) i conduttori in bassa tensione (230V) dai conduttori in bassissima tensione di sicurezza (SELV) oppure utilizzare un'adeguata guaina che fornisca un isolamento supplementare avente uno spessore di almeno 1 mm.

English GENERAL NOTICE FOR THE INSTALLER AND THE USER

1. Read carefully these Instructions before beginning to install the product. Store these instructions for future reference
2. Don't waste product packaging materials and /or circuits.
3. This product was designed and built strictly for the use indicated in this documentation. Any other use, not expressly indicated here, could compromise the good condition/operation of the product and/or be a source of danger. SEA srl declines all liability caused by improper use or different use in respect to the intended one.
4. The mechanical parts must be comply with Directives: Machine Regulation 2006/42/CE and following adjustments), Low Tension (2006/95/CE), electromagnetic Consistency (2004/108/CE) Installation must be done respecting Directives: EN12453 and En12445.
5. Do not install the equipment in an explosive atmosphere.
6. SEA srl is not responsible for failure to observe Good Techniques in the construction of the locking elements to motorize, or for any deformation that may occur during use.
7. Before attempting any job on the system, cut out electrical power and disconnect the batteries. Be sure that the earthing system is perfectly constructed, and connect it metal parts of the lock.
8. Use of the indicator-light is recommended for every system, as well as a warning sign well-fixed to the frame structure.
9. SEA srl declines all liability as concerns the automated system's security and efficiency, if components used, are not produced by SEA srl.
10. For maintenance, strictly use original parts by SEA.
11. Do not modify in any way the components of the automated system.
12. The installer shall supply all information concerning system's manual functioning in case of emergency, and shall hand over to the user the warnings handbook supplied with the product.
13. Do not allow children or adults to stay near the product while it is operating. The application cannot be used by children, by people with reduced physical, mental or sensorial capacity, or by people without experience or necessary training. Keep remote controls or other pulse generators away from children, to prevent involuntary activation of the system.
14. Transit through the leaves is allowed only when the gate is fully open.
15. The User must not attempt to repair or to take direct action on the system and must solely contact qualified SEA personnel or SEA service centers. User can apply only the manual function of emergency.
16. The power cables maximum length between the central engine and motors should not be greater than 10 m. Use cables with 2,5 mm² section. Use double insulation cable (cable sheath) to the immediate vicinity of the terminals, in particular for the 230V cable. Keep an adequate distance (at least 2.5 mm in air), between the conductors in low voltage (230V) and the conductors in low voltage safety (SELV) or use an appropriate sheath that provides extra insulation having a thickness of 1 mm.

Français CONSIGNES POUR L'INSTALLATEUR ET L'UTILISATEUR

1. Lire attentivement les instructions avant d'installer le produit. Conserver les instructions en cas de besoin.
2. Ne pas dispenser dans l'environnement le matériel d'emballage du produit et/ou des circuits
4. Ce produit a été conçu et construit exclusivement pour l'usage indiqué dans cette fiche. Toute autre utilisation non expressément indiquée pourraient compromettre l'intégrité du produit et/ou représenter une source de danger. SEA srl décline toute responsabilités qui dériverait d'usage improprie ou différent de celui auquel l'automatisme est destiné. Une mauvaise utilisation cause la cessation de la garantie.
5. Les composants doivent répondre aux prescriptions des Normes: Machines (2006/42/CE et successifs changements); Basse Tension (2006/95/CE et successifs changements); EMC (2004/108/CE et successifs changements). L'installation doit être effectuée conformément aux Normes EN 12453 et EN 12445.
6. Ne pas installer l'appareil dans une atmosphère explosive.
7. SEA srl n'est pas responsable du non-respect de la Bonne Technique de construction des fermetures à motoriser, ni des déformations qui pourraient intervenir lors de l'utilisation.
8. Couper l'alimentation électrique et déconnecter la batterie avant toute intervention sur l'installation. Vérifier que la mise à terre est réalisée selon les règles de l'art et y connecter les pièces métalliques de la fermeture.
9. On recommande que toute installation soit doté au moins d'une signalisation lumineuse, d'un panneau de signalisation fixé, de manière appropriée, sur la structure de la fermeture.
10. SEA srl décline toute responsabilité quant à la sécurité et au bon fonctionnement de l'automatisme si les composants utilisés dans l'installation n'appartiennent pas à la production SEA.



11. Utiliser exclusivement, pour l'entretien, des pièces SEA originales.
12. Ne jamais modifier les composants d'automatisme.
13. L'installateur doit fournir toutes les informations relatives au fonctionnement manuel du système en cas d'urgence et remettre à l'Usager qui utilise l'installation les "Instructions pour l'Usager" fournies avec le produit.
14. Interdire aux enfants ou aux tiers de stationner près du produit durant le fonctionnement. Ne pas permettre aux enfants, aux personnes ayant des capacités physiques, mentales et sensorielles limitées ou dépourvues de l'expérience ou de la formation nécessaires d'utiliser l'application en question. Eloigner de la portée des enfants les radiocommandes ou tout autre générateur d'impulsions, pour éviter tout actionnement involontaire de l'automatisme.
15. Le transit entre les vantaux ne doit avoir lieu que lorsque le portail est complètement ouvert.
16. L'utilisateur doit s'abstenir de toute tentative de réparation ou d'intervention et doit s'adresser uniquement et exclusivement au personnel qualifié SEA ou aux centres d'assistance SEA. L'utilisateur doit garder la documentation de la réparation. L'utilisateur peut exécuter seulement la manoeuvre manuel.
17. La longueur maximum des câbles d'alimentation entre la carte et les moteurs ne devrait pas être supérieure à 10 m. Utilisez des câbles avec une section de 2,5 mm². Utilisez des câblage avec câble à double isolation (avec gaine) jusqu'à proximité immédiate des terminaux, en particulier pour le câble d'alimentation (230V). Il est également nécessaire de maintenir une distance suffisante (au moins 2,5 mm dans l'air), entre les conducteurs en basse tension (230V) et les conducteurs de très basse tension de sécurité (SELV) ou utiliser une gaine ayant une épaisseur d'au moins 1 mm, qui fournisse une isolation supplémentaire.

Español ADVERTENCIAS GENERALES PARA INSTALADORES Y USUARIOS

- 1 Leer las instrucciones de instalación antes de comenzar la instalación. Mantenga las instrucciones para consultas futura
2. No desperdiciar en el ambiente los materiales de embalaje del producto o del circuito
3. Este producto fue diseñado y construido exclusivamente para el uso especificado en esta documentación. Cualquier otro uso no expresamente indicado puede afectar la integridad del producto y ser una fuente de peligro. El uso inadecuado es también causa de anulación de la garantía. SEA srl se exime de toda responsabilidad causadas por uso inapropiado o diferente de aquel para el que el sistema automatizado fue producido.
4. Los productos cumplen con la Directiva: Maquinas (2006/42/CE y siguientes modificaciones), Baja Tension (2006/95/CE, y siguientes modificaciones), Compatibilidad Electromagnética (2004/108/CE modificada). La instalación debe ser llevada a cabo de conformidad a las normas EN 12453 y EN 12445.
5. No instalar el dispositivo en una atmósfera explosiva.
6. SEA srl no es responsable del incumplimiento de la mano de obra en la construcción de la cancela a automatizar y tampoco de las deformaciones que puedan producirse durante el uso.
7. Antes de realizar cualquier operación apagar la fuente de alimentación y desconectar las baterías. Comprobar que el sistema de puesta a tierra sea diseñado de una manera profesional y conectar las partes metálicas del cierre.
8. Para cada instalación se recomienda utilizar como mínimo una luz parpadeante y una señal de alarma conectada a la estructura del marco.
9. SEA srl no acepta responsabilidad por la seguridad y el buen funcionamiento de la automatización en caso de utilización de componentes no producidos por SEA.
10. Para el mantenimiento utilizar únicamente piezas originales SEA srl.
11. No modificar los componentes del sistema automatizado.
12. El instalador debe proporcionar toda la información relativa al funcionamiento manual del sistema en caso de emergencia y darle al usuario el folleto de adjunto al producto.
13. No permita que niños o adultos permanecen cerca del producto durante la la operación. La aplicación no puede ser utilizada por niños, personas con movilidad reducida de tipo físico, mental, sensorial o igual por personas sin experiencia o formación necesaria. Tener los radiomandos fuera del alcance de niños así como cualquier otro generador de impulsos radio para evitar que el automación pueda ser accionada accidentalmente.
14. El tránsito a través de las hojas sólo se permite cuando la puerta está completamente abierta.
15. Todo el mantenimiento, reparación o controles deberán ser realizados por personal cualificado. Evitar cualquier intento a reparar o ajustar. En caso de necesidad comunicarse con un personal SEA calificado. Sólo se puede realizar la operación manual.
16. La longitud máxima de los cables de alimentación entre motor y central no debe ser superior a 10 metros. Utilizar cables con 2,5 mm². Utilizar cables con doble aislamiento (cables con vaina) hasta muy cerca de los bornes, especialmente por el cable de alimentación (230V). Además es necesario mantener adecuadamente distanciados (por lo menos 2,5 mm en aire) los conductores de baja tensión (230V) y los conductores de baja tensión de seguridad (SELV) o utilizar una vaina adecuada que proporcione aislamiento adicional con un espesor mínimo de 1 mm.

Deutsch ALLGEMEINE HINWEISE UND VERPFLICHTUNGEN FÜR DIE SICHERHEIT

1. Lesen Sie die Installationsanweisungen sorgfältig durch, bevor Sie mit der Installation beginnen. Diese Installationsanweisungen gut aufbewahren.
2. Das Verpackungsmaterial des Produkts und/oder des Schaltkreises umweltgerecht entsorgen
3. Dieses Produkt wurde speziell und ausschließlich für den, in den Unterlagen beschriebenen Zweck, geplant und hergestellt. Jede andere Verwendung, die nicht ausdrücklich angegeben wurde kann die Integrität des Produkts und/oder eine Gefahrenquelle darstellen. Die nicht fachgerechte Nutzung des Produkts bewirkt die Erlöschung der Garantie. SEA GmbH lehnt jegliche Haftung, für unsachgemäße oder andere Nutzung, als die wofür das Produkt bestimmt ist, ab.
4. SEA Produkte entsprechen den folgenden Richtlinien: Maschinenrichtlinie (2006/42/EG und nachträglich geänderten Fassungen), Niederspannungs-Richtlinie (2006/95/EG und nachträglich geänderten Fassungen), EMV (2004/108/EG und nachträglich geänderten Fassungen). Installation gemäß Standard EN12453 und EN12445 durchführen.
5. Installieren Sie das Gerät nicht in explosionsgefährdeten Bereichen, das Vorhandensein von brennbaren Gasen oder Dämpfen stellt ein ernstes Sicherheitsrisiko dar.
6. SEA GmbH ist nicht, für die Nichtbeachtung der Guten Technik bei der Herstellung von zu motorisierenden Toren und für deren eventuellen Verformungen, die während des Gebrauchs auftreten könnten, haftbar.
7. Vor allen Eingriffen, das Gerät ausschalten und die Batterien trennen. Sicherstellen, dass die Erdung fachgerecht hergestellt wurde und die Metallteile des Tores daran anschließen.
8. Für jede Anlage wird empfohlen, mindestens ein Blinklicht zu montieren und ein Warnschild auf der Rahmenstruktur anzubringen.
9. SEA GmbH übernimmt keine Haftung für Sicherheit und reibungslosen Betrieb der Automation, bei Verwendung von Komponenten, die nicht von der SEA Produktion stammen.
10. Für die Wartung nur SEA Originalteile verwenden.
11. Keinerlei Änderungen auf Komponenten der Automation vornehmen.
12. Der Installateur muss den Nutzer der Automation über den manuellen Betrieb des Systems im Notfall unterrichten und ihm, die, dem Produkt beiliegende, Broschüre übergeben.
13. Der Aufenthalt von Kinder oder Erwachsenen in der Nähe des Gerätes während des Betriebes ist zu untersagen. Die Anlage darf nicht von Kindern, Personen mit eingeschränkten körperlichen, geistigen oder sensorischen Fähigkeiten oder von Menschen ohne notwendige Erfahrung oder Ausbildung benutzt werden. Fernbedingungen oder andere Impulsgeber außerhalb der Reichweite von Kindern halten, um die versehentliche Aktivierung der Anlage zu verhindern.
14. Die Durchfahrt zwischen den Flügeln ist nur bei vollständig geöffnetem Tor zulässig.
15. Sämtliche Wartungs-, Reparaturarbeiten oder periodische Kontrollen, müssen von qualifiziertem Fachpersonal durchgeführt werden, und müssen dokumentiert und vom.
16. Die maximale Länge der Anschlussleitungen von der zentralen Motor und sollte nicht größer als 10 m. Die Verwendung von Kabeln mit 2,5 mm². Verwenden Sie Kabel mit Kabel mit Doppel-Isolierung (Kabelmantel) in die unmittelbare Nähe des Terminals, insbesondere die Befugnis (230V). Es ist auch notwendig, um einen ausreichenden Abstand (mindestens 2,5 mm zu halten in Luft), die Leiter in Niederspannung (230V) von der Leiter in Niederspannung Sicherheit (SELV) oder verwenden Sie eine geeignete Hülle, die zusätzliche Isolierung sorgt mit einer Dicke von 1 mm.



Dichiarazione di conformità
Declaration of Conformity

La SEA s.r.l. dichiara sotto la propria responsabilità e, se applicabile, del suo rappresentante autorizzato che il prodotto:

SEA srl declares under its proper responsibility and, if applicable, under the responsibility of its authorised representative that the product:

Descrizione / Description	Modello / Model	Marca / Trademark
Centrale di comando User 1 24V (e tutti i suoi derivati)	23024060/65	SEA
<i>Control Unit User 1 24V (and all its by-products)</i>	<i>23024060/65</i>	<i>SEA</i>

è costruito per essere incorporato in una macchina o per essere assemblato con altri macchinari per costruire una macchina ai sensi della Direttiva 2006/42/CE:

is built to be integrated into a machine or to be assembled with other machinery to create a machine under the provisions of Directive 2006/42/CE:

è conforme ai requisiti essenziali di sicurezza relativi al prodotto entro il campo di applicabilità delle Direttive Comunitarie 2006/95/CE e 2004/108/CE.

it is conforming to the essential safety requirements related to the product within the field of applicability of the Community Directives 2006/95/CE and 2004/108/CE.

COSTRUTTORE o RAPPRESENTANTE AUTORIZZATO:
MANUFACTURER or AUTHORISED REPRESENTATIVE:

SEAS.r.l.
DIREZIONE E STABILIMENTO:
Zona industriale 64020 S.ATTO Teramo - (ITALY)
Tel. 0861 588341 r.a. Fax 0861 588344
Http://www.seateam.com

I test sul prodotto sono stati effettuati in configurazione standard e in riferimento alle norme specifiche per la sua classe d'utilizzo.

The products have been tested in standard configuration and with reference to the special norms concerning the classe of use.

(Luogo, data di emissione)
(Place, date of issue)
Teramo, 25/06/2010

L'Amministratore
The Administrator
Ennio Di Saverio



SEA[®]
electronic opening system

Questo articolo è stato prodotto seguendo rigide procedure di lavorazione ed è stato testato singolarmente al fine di garantire i più alti livelli qualitativi e la vostra soddisfazione. Vi ringraziamo per aver scelto SEA.

This item has been produced following strict production procedures and has been singularly tested for the highest quality levels and for your complete satisfaction. Thanks for choosing SEA.

Cet article a été produit suivant des procédures d'usinage strictes et il a singulièrement été testé afin de garantir les plus hauts niveaux de qualité pour votre satisfaction. Nous vous remercions d'avoir choisi SEA.

Este artículo ha sido producido siguiendo rigidos procedimientos de elaboración y ha sido probando singolarmente a fin de garantizar los mas altos niveles de calidad y vuestra satisfaccion. Le agradecemos por haber escogito SEA.



SEA s.r.l.
Zona Ind.le S. Atto - 64020 S. Nicolò a Tordino (TE)
Tel. 0861.588341 - Fax 0861.588344

www.seateam.com

e-mail: seacom@seateam.com