



LIGHT-INDUSTRIAL SLIDING GATE OPERATOR

Company overview

Centurion Systems (Pty) Ltd, South Africa, has been manufacturing automatic gate systems since 1986, and is committed to providing reliable, cost effective solutions in the field of gate and access automation.

We offer a diverse range of products including gate motors, GSM-based products, garage door motors, remote controls, keypads, traffic barriers, proximity access control and intercom systems.

Our products are developed by an in-house team of talented engineers that are constantly researching new and innovative technologies to improve our existing products and expand our product range.

Our production facility in Johannesburg is ISO:9001 quality assurance certified, and all our products are manufactured to the highest level of quality with a 100% test to specification.

Through a team of dedicated technicians and sales personnel, together with a fully fledged in-house training facility, we are committed to providing unmatched service to our customers and support for our products.

A worldwide network of distributors and installers ensure that our products remain The Automatic Choice in access automation .

Further information is available on our website www.centsys.com.au



Centurion Systems (Pty) Ltd reserves the right to make changes to the products described in this document without notice and without obligation of Centurion Systems (Pty) Ltd to notify any persons of any such revisions or changes. Additionally, Centurion Systems (Pty) Ltd makes no representations or warranties with respect to this document.

No part of this document may be copied, stored in a retrieval system or transmitted in any form or by any means electronic, mechanical, optical or photographic, without the express prior written consent of Centurion Systems (Pty) Ltd.

Contents



IMPORTANT SAFETY FEATURES

	page 1
Introduction	page 2
D5-Evo overview	page 2
D10 overview	page 3
D10 Turbo overview	page 4
1. D5-Evo parts identification	page 5
2. D10 and D10 Turbo parts identification	page 6
3. D5-Evo manual Override	page 6
3.1. Disengage the gearbox/drive	page 6
3.2. Re-engage the gearbox/drive	page 7
4. D10 and D10 Turbo manual override	page 7
4.1. Disengage the gearbox/drive	page 7
4.2. Manual release latching	page 8
5. Features and functions	page 8
Introduction	page 8
5.1. Gate Operation	page 8
5.1.1. Full Gate Opening	page 8
5.1.2. Modes of Operation	page 8
5.1.2.1. Standard Mode	page 9
5.1.2.2. Reversing Mode	page 9
5.1.2.3. Condominium Mode	page 10
5.1.2.4. PLC Mode	page 10
5.1.2.5. Deadman Mode	page 11
5.1.3. Automatic Closing (Autoclose Mode)	page 11
5.1.3.1. Autoclose Override	page 12
5.1.3.2. Autoclose Advanced Option	page 12
5.1.4. Pedestrian Opening	page 13
5.1.5. Free-exit Opening	page 14
5.1.6. PIRAC Mode (Beam Autoclose) - optional	page 15
5.1.6.1. PIRAC Override	page 15
5.1.7. Holiday Lockout Mode	page 16
5.1.6.1. Emergency stop	page 16
5.1.8. Positive Close Mode	page 16
5.1.9. Operator Run Profiles	page 17
5.1.10. Anti-crushing Sensitivity	page 17
5.1.10.1 Collision Count	

5.1.11.	Safety beams (optional, but recommended feature)	page 18
5.1.11.1.	Closing Safety Beams	page 18
5.1.11.2.	Opening Safety Beams	page 18
5.1.12.	Intruder-detection Alarm (a world first)	page 19
5.1.12.1.	Ambush Alarm	page 19
5.1.12.2.	Break-in Alarm	page 19
5.1.13.	External Gate Status Indication LED	page 20
5.1.14.	Courtesy (Pillar) Light Timer (optional feature)	page 20
5.1.14.1.	Courtesy (Pillar) Light Control	page 21
5.1.14.2.	Courtesy (Pillar) Light act as Warning Light	page 21
5.1.14.3.	Pre-open and pre-close delay	page 21
5.1.15.	Onboard Multichannel Receiver	page 22
5.1.16.	ChronoGuard Timer (a world first)	page 23
5.1.16.1.	Some examples of how to use ChronoGuard	page 24
5.1.17.	Battery Low Protection	page 25
6.	Additional features	page 26
6.1.	Battery saver	page 26
6.2.	Solar power supply	page 26
6.2.1	D5-Evo	page 26
6.2.2	D10 and D10 Turbo	page 26
6.3	Lightning protection	page 27
7.	Basic Maintenance	page 28
8.	Diagnostics	page 29
9.	Specifications	page 30
10.	24 Month product warranty	page 31
11.	Optional extras	page 33

Icons used in this user guide



This icon indicates tips and other information that could be useful during the installation



This icon denotes variations and other aspects that should be considered during installation



This icon indicates warning, caution or attention! Please take special note of critical aspects that **MUST** be adhered to in order to prevent injury

IMPORTANT Safety instructions



Even if you have owned and used an automated gate before, we suggest that you read through the safety instructions below very carefully. Although years of thought have been put into every CENTSYS product – and your safety is our top priority – accidents do happen. So, please make sure that you fully understand the following safety requirements before using your automated gate.

Before you attempt to use your new gate operator for the first time, you should know:

- How to operate the Manual Release thumbwheel
- How the Obstruction Detection System and all other safety features work
- All the safety considerations that come with operating an automated gate – and the importance of explaining these considerations to everyone who uses the operator

DOs and DON'Ts

1. Do not activate your gate opener unless you can see it. Make sure that no people, pets or any other obstructions are in your gate's area of travel.
2. NO ONE MAY CROSS THE PATH OF A MOVING GATE. Our advanced obstruction detection technology is designed to stop your gate in its tracks should a child or pet be in the way. However this is a reactive system and should never supersede proactive measures of preventing people, pets or vehicles from moving into the path of a moving gate.
3. Check if the obstruction detection system and safety devices for correct operation are in working order once a month.
4. Children should be supervised to ensure that they do not play with the appliance.
5. This appliance is not intended for use by persons (including children) with reduced physical, sensory or mental capabilities, or lack of experience and knowledge, unless they have been given supervision or instruction concerning use of the appliance by a person responsible for their safety.
6. Always be mindful of where your limbs are when dealing with moving parts – you don't want your fingers to be pinched (or worse).
7. Keep your gate controls (remote controls) in a safe place. You don't want anyone getting in uninvited.
8. Look after your gate and it will look after you. Ensure that all working areas are debris-free and that your automated system is well-maintained and your CENTSYS operator should last you a very long time.
9. Ensure that any technician that works on your operator has been trained by CENTSYS.
10. This product was designed and built strictly for the use indicated in this documentation. Any other use, not expressly indicated here, could compromise the good condition/operation of the product and/or be a source of danger.
11. Centurion Systems (Pty) Ltd does not accept any liability caused by improper use of the product, or for use other than that for which the automated system was intended.

**Safety
FIRST**

Introduction

This User Guide contains all the information you need to configure and operate your new **D5-Evo, D10 or D10 Turbo** Sliding Gate Operator. From safety instructions to basic principles of operation and an in-depth description of your CENTSYS product's many features and functions. By the time you have finished reading this guide you will have learnt how to make the most out of your gate operator. Even basic maintenance is covered but, in the unlikely event that your CENTSYS product malfunctions, rather leave it to the professionals and contact your installer or nearest CENTSYS outlet (contact details listed on the back page) for prompt assistance.

D5-Evo overview

The **D5-Evo** is driven by a high torque 12V DC motor which can effortlessly shift gates weighing up to 500kg – perfect for domestic and light industrial use. The gearbox moulded from a high-tech engineering polymer not only looks good, but is corrosion-free and guarantees that even if you live on the coast, your **D5-Evo** will just keep on going. For your security, the internal gearset has a self-locking action so forced entry is no longer an option for would-be burglars. An optional theft-resistant cage makes intruders' lives even more difficult. For your safety, our revolutionary limit switch mechanism monitors the speed and location of your gate for accurate position control and sensitive anti-crushing protection.

The **D5-Evo** is packed with features and functions, all easily accessible from a user-friendly LCD controller. Multiple Modes of Operation, alarm functions, an onboard multichannel receiver, ChronoGuard full 7 day timer – you name it, the **D5-Evo's** got it. The integral 12V 7 Ah battery (charged by an internal 220V charger) comes with full battery back-up and advanced lightning protection so you can always get in – even when the power is out. It is important to note that the battery is the primary power source of the **D5-Evo**.

You can increase the capacity of the battery with an externally mounted battery to give longer power failure autonomy.

Instead of the 220V charger, you can have a low voltage charger mounted inside the **D5-Evo** with a plug-in transformer plugged into the nearest plug point inside the house / building. This saves having to run an electrically compliant 220-240V supply to the **D5-Evo**.

Finally you can use a solar panel to charge the battery. See section 6.2 (**Solar power supply**), for more details about solar charging).

D10 overview

The **D10**'s 24V DC motor is coupled to the gearbox, resulting in a combination of speed and power that can push up to a 1000kg sliding gate – perfect for industrial sites such as business parks, housing estates and factories. The precision machined, die cast aluminium gearbox incorporates a self-locking gearset and not only makes short work of massive gates, but the attempts of prospective criminals too. Add the optional theft resistant cage and criminals will have to think about a change of occupation. A 24V 7Ah battery supply with a switch mode charger means your batteries are always full, but if you're still hungry for power the battery capacity can be increased by using an externally mounted unit. Similar to the **D5-Evo**, the **D10/D10 Turbo** batteries can also be charged by a solar panel instead of a 220V mains supply at the gate.

As with the **D5 Evo**, the **D10/D10 Turbo** controller with LCD interface is a cinch to set up and it offers an equally impressive list of useful features including CENSYS's ChronoGuard timer technology. Of course accurate position control, sensitive anti-crushing and precision stopping power come standard.

D10 Turbo overview

The **D10 Turbo** is perfectly suited for sites requiring a high number of operations per day, and very fast opening and closing speeds, and can reach almost double the speed of the standard **D10**. However, it is recommended that gates weighing more than 240kg are not operated at maximum speed, as the inertia generated by heavier loads might prove detrimental to the gearbox at such high speeds.

1. D5-Evo parts identification

Refer to the drawings below, for how to identify your **D5-Evo** operator and its parts.

1. **D5-Evo** controller
2. Courtesy light fuse (3A F/B)
3. Gate mounted origin Marker
4. Origin marker bracket
5. Origin sensor
6. Side covers
7. Foundation plate
8. Motor fuse (30A ATO)
9. 1 x 12V 7.2Ah battery
10. 2A 12V charger
11. Lockable Manual release access door
12. Encoder sensor (clips into support post)

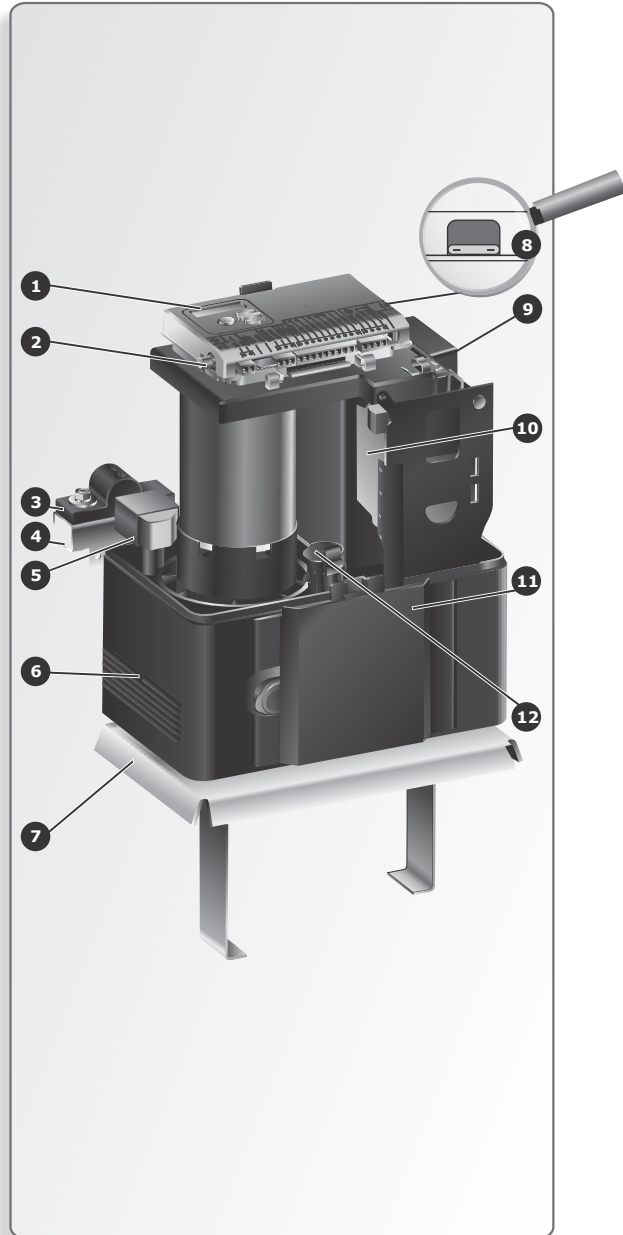

2. D10/D10 Turbo parts identification

Refer to the drawings below, for how to identify your **D10/D10 Turbo** operator and its parts.

1. **D10/D10 Turbo** controller
2. Courtesy light fuse (3A F/B)
3. 2 x 12V 7.2Ah battery
4. Gate mounted origin marker
5. Origin marker bracket
6. Origin sensor (clip under battery)
7. Lower cover
8. Foundation plate
9. Motor fuse (30A ATO)
10. **D10/D10 Turbo** charger
11. Manual release handle
12. Lock cover
13. Encoder sensor (clip behind charger)



3. D5-Evo Manual override

Manual Override

3.1. Disengaging the gearbox/drive

Carefully flip to the side the camlock cover and insert the key and rotate it 90° clockwise.

While holding onto the key, pull open the access door to expose the manual override thumbwheel. This will allow for the removal of the cover, as well as for the rotation of the release thumbwheel.

Rotate the thumbwheel clockwise until gearbox releases and gate can be moved manually.

If the gearbox must be left in manual mode for an extended period of time for whatever reason, it is recommended that the access door is locked. This secures the cover and prevents access to the inside of the unit, which could contain high voltages. It also prevents theft of any components and provides full protection from the elements.

 Do not remove the thumbwheel. Removal of the thumbwheel may result in water entering the gearbox and the warranty will be void.

3.2. Re-engaging gearbox/drive

Rotate thumbwheel anti-clockwise until thumbwheel feels loose in the hand. Make sure that the manual override access door can be closed.

Slide gate until gearbox/drive engages. Never run the motor before the unit is engaged.



FIGURE 3

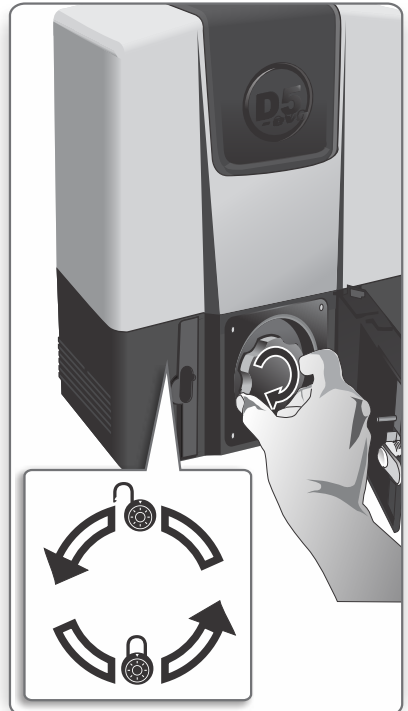

FIGURE 4

4. D10/D10 Turbo Manual override

4.1. Disengaging the gearbox/drive

Flip down the lock cover and
Insert the camlock key and
rotate it 90° clockwise.

Pull down the manual release
handle to override the gearbox
and allow it to be moved
manually

Reverse the process to re-
engage the gearbox/drive.

4.2. Manual release latching

If the gearbox must be left in
manual mode for an extended
period of time for whatever
reason, it is recommended that
the manual release is latched,
the handle raised back into its
normal position and locked,
locking the cover in place at the
same time. This prevents access
to the inside of the unit, which
contains high voltages and
prevents theft of any
components and provides full
protection from the elements.

With the manual release handle
pulled down, follow the process
below to latch the manual
release.

- Insert the split pin (supplied with the mounting hardware kit), through the hole in the gearbox as indicated
- Make sure the split pin goes all the way through as shown
- Raise the handle and lock
- Remove the key and fold back the lock cover



FIGURE 5

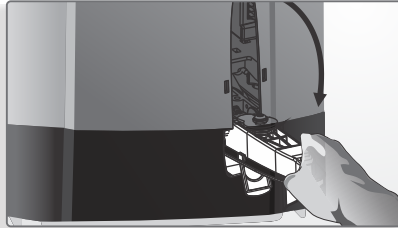

FIGURE 6

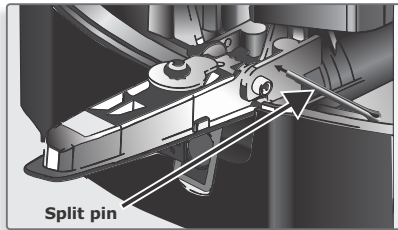

FIGURE 7

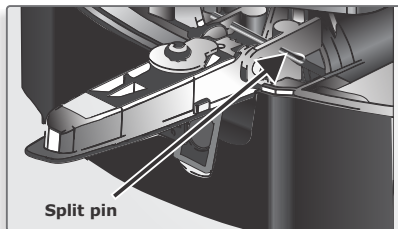

FIGURE 8



FIGURE 9

Manual
Override

5. Features and functions

Introduction

The **D5-Evo** and **D10/D10 Turbo** sliding gate operators' advanced functions are controlled by intelligent micro-controller based electronic controllers.

An intuitive LCD (Liquid Crystal Display) controller with a user-friendly menu allows for quick and easy set-up and the ability to change functions at the touch of a button and displays useful diagnostics.

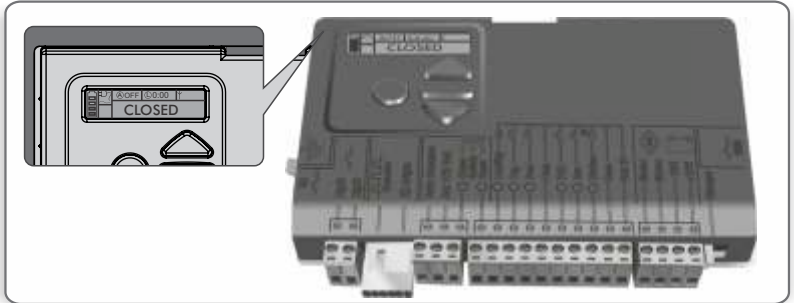

FIGURE 10

5.1. Gate operation

5.1.1. Full Gate Opening

The CENTSYS remote controls that operate with the onboard receivers of the **D5-Evo**, **D10** and **D10 Turbo** sliding gate operators are used to operate the gate. However, most automatic gate installations are also fitted with an intercom, which provides for communication between the house / building and the gate. The handset is usually fitted with a gate / door release pushbutton, which when pressed, will operate the gate.



FIGURE 11

5.1.2. Modes of Operation

To operate the gate to open fully, the **D5-Evo**, **D10** and **D10 Turbo** have a number of operating modes to choose from depending on the application. Only one mode can be selected at any given time.

- **5.1.2.1. Standard Mode**

Standard Mode is the most commonly used mode for domestic applications as it allows full control of the gate. Press the button of the remote control or the gate / door release pushbutton on the intercom for approximately one second to get the gate in motion

If you press the button again, while the gate is moving, the gate will stop. Press the button for a third time and the gate will go into reverse



Autoclose (page 11) and PIRAC (Beam Autoclose) (page 14) can be used with Standard Mode. An infrared safety beam needs to be installed across the gate entrance and connected to the Closing Safety Beam input on the **D5-Evo** or **D10/D10 Turbo** to use this function, in order to prevent the gate from closing on people, pets or vehicles. (Page 18)

- **5.1.2.2. Reversing Mode**

Reversing Mode offers slightly more security than Standard Mode as it allows you to close your gate quickly by pressing, for instance, your remote control just as you drive through the gate to prevent children or pets running out - or anybody getting in behind you

When pressing the button of the remote control or the gate / door release pushbutton on the intercom, your gate will be set in motion. If you press the button again, the gate will move in the opposite direction. So, if the gate is opening and you press the button, the gate will stop and immediately start to close (and vice versa)



Autoclose (page 11) and PIRAC (Beam Autoclose) (page 14) can be used with Reversing Mode. An infrared safety beam needs to be installed across the gate entrance and connected to the Closing Safety Beam input on the **D5-Evo** or **D10/D10 Turbo** to use this function, in order to prevent the gate from closing on people, pets or vehicles. (Page 18)

- **5.1.2.3. Condominium Mode**

This mode is ideal for increased safety and security in multi-user applications such as townhouses, estates, factories or office parks.

If you select Condominium Mode, your gate will open when pressing the button of the remote control or the gate / door release pushbutton on the intercom – but pressing the button again while gate is opening will be ignored. It will not cause the gate to stop or to reverse. Only the internal Autoclose described on page 11 of this User Guide, which is automatically enabled, will close the gate. If the button of the remote control or intercom gate release is pressed while the gate is closing, the gate will immediately reopen. The gate cannot be stopped in a midway position and will therefore always close. If the button is pressed while the gate is in the open position, the Autoclose timer (Page 11) is reset. Finally, the Autoclose Override feature described on page 11 cannot be applied in this mode



We highly recommend that you use protection beams if you select Condominium Mode in order to prevent the gate from closing on people, pets or vehicles.



PIRAC (Beam Autoclose) (page 11) can be used with Condominium Mode.

• **5.1.2.4. PLC Mode**

This highly specialised mode is suited to industrial applications where a separate computer or programmable logic controller (PLC) is used to operate the gate. Three separate inputs are used to open, stop or close the gate:

- Free-exit input (a trigger from the PLC will only open the gate)
- Holiday Lockout input (a trigger from the PLC will stop the gate)
- Trigger input (a trigger will only close the gate)

Autoclose (page 11) and PIRAC (Beam Autoclose) (page 14) cannot be used with PLC Mode

• **5.1.2.5. Deadman Control Mode**

A variation of PLC Mode, Deadman Control Mode requires a pushbutton to be held in order for the gate to be set in motion. If the button is released, the gate will immediately stop

Alternatively, an emergency stop pushbutton can be used to permanently hold the gate in "Stop Mode". Releasing the pushbutton will allow your gate to open or close

If the open or closed triggers are held when the gate reaches the end of its cycle either fully open or fully closed, the internal end-of-travel limit switch system will shut off the motor and prevent further operation in the respective direction

Autoclose (page 11) and PIRAC (Beam Autoclose) (page 14) cannot be used with Deadman Control Mode

5.1.3. Automatic closing (Autoclose Mode)

The **D5-Evo** and the **D10-D10 Turbo** sliding gate operators have the facility to automatically close the gate after it has opened. When enabling this feature, the time that the gate stays open is by default fifteen seconds (this time is adjustable*).

As described in the previous section Autoclose is selectable with Standard and Reversing Modes (page 9) and by default the function is off. However, Autoclose is automatically enabled in Condominium Mode.



We highly recommended that a safety beam is installed across the gate entrance and connected to the Closing Safety Beam input on the **D5-Evo**, the **D10** and the **D10 Turbo**. if you enable Autoclose Mode, in order to prevent the gate from closing on people, pets or vehicles

* It is possible to adjust the delay before the gate closes in one second increments from zero seconds to four minutes. The default time is five seconds.

• 5.1.3.1. Autoclose Override

Automatic closing can be overridden in Standard and Reversing Modes by pressing and holding the button of the remote control or intercom gate release for no less than three seconds. The gate response will be to start opening and then to stop as soon as the Autoclose Override feature is activated. On releasing the button, the gate will continue opening until fully open

Your gate will stay open until you use the remote control or intercom gate release to close the gate. The **D5-Evo**, the **D10** and the **D10 Turbo** will then revert to normal Autoclose operation



The Autoclose function cannot be overridden in Condominium Mode

It is possible to adjust the override time or the override time or hold down the button in order to override Autoclose in one second increments from one to ten seconds. The default time is three seconds

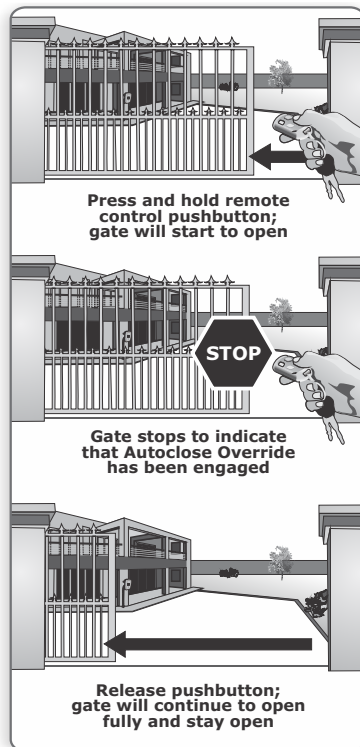

FIGURE 12

- **5.1.3.2. Autoclose advanced options**

You can also independently set Autoclose to function when the gate is partly open, fully open or partly closed

For example, disable Autoclose when the gate is partly closed to allow construction workers, gardeners, etc access to your property (although this comes with security risks). By enabling the Autoclose in all states of gate movement, ensures that the gate can never be left in any position other than fully closed. The default setting when enabling Advanced Autoclose is partly open and fully open, but not partly closed

5.1.4. Pedestrian Opening

The Pedestrian Opening input opens the gate just wide enough for a pedestrian to pass through the opening. A second button on your remote control can be used to operate the Pedestrian Opening function. You can also set a keyswitch or keypad mounted adjacent the gate entrance to operate this function.

There is a default, but adjustable, two second delay before the gate opens to warn the pedestrian that the gate is about to move as well as give the person enough time to move their hand away if they are reaching through the gate to operate a keyswitch or a keypad*.

If the Courtesy Light (Page 20) is connected to the control card, it will flash indicating that the gate will open a default distance of approximately one metre (adjustable). The gate will close after a default time of five seconds (adjustable).



FIGURE 13



FIGURE 14

The gate can be kept open by keeping a trigger on the input (keeping your key in the keyswitch, for example) – once removed the gate will close after the default, but adjustable, five seconds.

The Pedestrian Opening Input is fully configurable and can be set to suit your needs. You can adjust the pre-opening time delay; the amount that the gate opens; and the pedestrian Autoclose delay using your LCD controller. Refer to the notes below.

If a Protection Beam (page 18) is fitted and the beam is broken while the gate is closing, the gate will stop and open to the pedestrian position. The gate will remain open while the beam is broken and the 5 second (adjustable) Autoclose delay will only commence once the beam has been cleared.



For safety reasons it is recommended that all pedestrian keyswitches and keypads are installed on the opposite end of the gate to where the operator is installed



It is possible to adjust the delay before the gate opens in one second increments from zero to 65 seconds (one minute and five seconds). The default time is two seconds

It is possible to adjust the width of the pedestrian opening from a minimum of 50 millimetres to the full gate opening in ten millimetre increments. The default opening is one metre

It is possible to adjust the delay before the gate closes in one second increments from zero to 65 seconds (one minute and five seconds).The default time is five seconds

5.1.5. Free-exit Opening

The Free-exit Opening allows visitors to exit townhouses, estates, factories or office parks easily.

An inductive ground loop is mounted under the driveway inside the property a short distance away from the gate. The output of the inductive ground loop detector is connected to the free-exit input on the controller.

When a vehicle drives over the loop, a detector senses the metal in the vehicle and activates the free-exit function which opens the gate. The ground loop cannot be activated by a person or any non-metallic objects and can be set to only activate if it detects a large amount of metal.

Free-exit never initiates a closing cycle so the Autoclose function (page 11) must be enabled in order for the gate to close.

If the gate is already open or opening, triggering the free-exit input will have no effect other than to reset the Autoclose timer. If the gate is closing, triggering the free-exit input will immediately stop and re-open the gate.

An infrared beam can be used instead of an inductive ground loop, but the beam will be activated if a person (or any object) moves through it, so this option is typically less secure.

Please contact Centurion Systems (Pty) Ltd for more information on whether a ground loop or infrared beam is better suited to your needs.

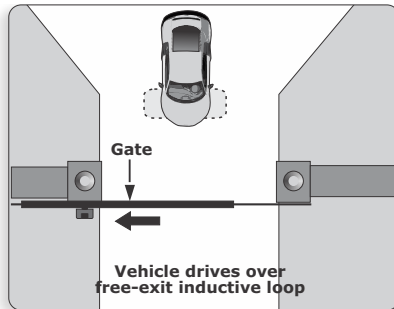

FIGURE 15

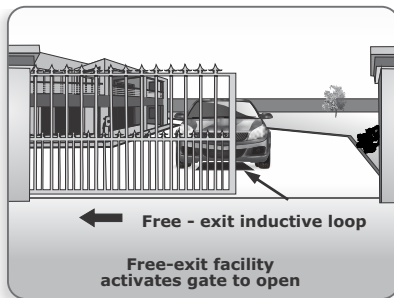

FIGURE 16

5.1.6. PIRAC Mode (Beam Autoclose Mode) - optional



This mode can only be used if a Closing Safety Beam (page 18) is fitted

This mode can be used in conjunction with any of the operating modes, Standard, Condominium and Reversing.

With PIRAC Mode enabled, your gate will close as soon as you have driven through and passed the safety beam – giving intruders no time to follow behind you.

If Autoclose is enabled and the gate has been opened but nothing moves through the Closing Safety Beam, the gate will stay fully open for the duration of the Autoclose timer before closing. However, if something passes through the Closing Safety Beam the gate will close immediately.

If something crosses the beam while the gate is opening, it will continue to open until the beam is cleared and the gate will then stop and close. If the gate has reached its fully open position, it would stop and remain open until the beam is cleared.

PIRAC mode's 'stop on opening' configuration will open the gate a short, adjustable distance past the point at which the beam was broken and stop, wait for the beam to be re-made or the Autoclose timer to expire, then close.

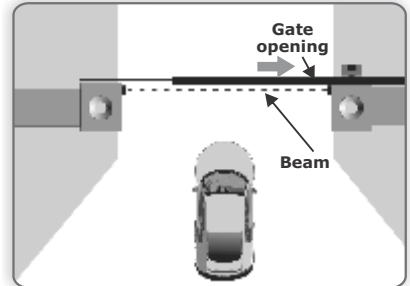

FIGURE 17

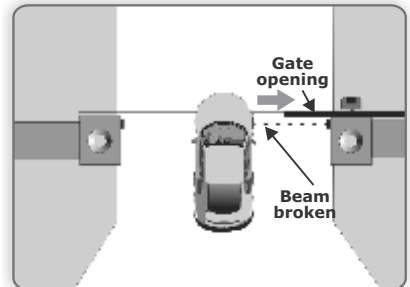

FIGURE 18

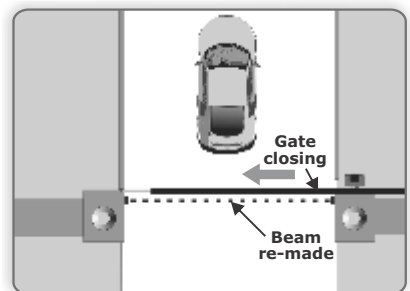

FIGURE 19

• 5.1.6.1 PIRAC Override

The PIRAC (Beam Autoclose Mode) can be overridden in Standard and Reversing Modes. Similar to overriding the Autoclose function you must press and hold the button of the remote control or intercom gate release for at least 6 seconds. The gate response will be to start opening and then to stop for a pause time of three seconds and then continue to open as soon as the PIRAC Override feature is activated. Once the gate resumes opening you may release the remote control button or intercom gate release and the gate will continue to the fully open position with PIRAC Mode overridden.

Your gate will stay open until you use the remote control or intercom gate release to close the gate. The **D5-Evo**, **D10** and the **D10 Turbo** will then revert to normal PIRAC operation.

5.1.7. Holiday Lockout Mode

This feature completely immobilises the operator and deactivates all inputs so nobody can get into your property while you are away.

One of the buttons on your remote control can be used to switch the Holiday Lockout Mode as well as a latching keyswitch or keypad mounted adjacent the gate entrance, accessible from the outside of the property.

When Holiday Lockout Mode is enabled, any of the access control devices that are connected to the **D5-Evo**, **D10** and the **D10 Turbo**, will be inactive and not even tampering with the keyswitch, keypad or access tag readers on the outside of the property, will open the gate – particularly useful if you intend leaving your property unattended for extended periods of time.

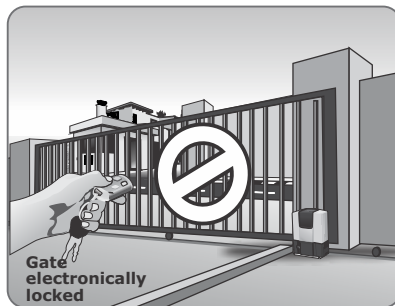

FIGURE 20

If Holiday Lockout Mode is enabled while the gate is moving or in the open position, it will only activate when the gate is back in the closed position.

If somebody tries to open the gate via a valid access control device, such as a remote control, etc. with Holiday Lockout Mode enabled, the onboard buzzer will beep periodically for 30 seconds to confirm that the gate operation has been disabled using this feature.

• 5.1.7.1. Emergency Stop

The Holiday Lockout function can also be used as an Emergency Stop function. Mount an emergency stop pushbutton in a weatherproof housing near the gate and you can bring your gate to an immediate stop with just one press. The emergency stop button must be reset before the gate can be operated again.

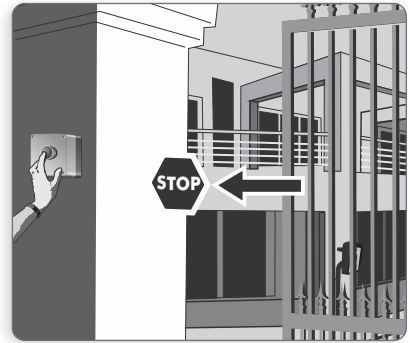

FIGURE 21



Emergency Stop will override normal Holiday Lockout Mode functions

If somebody tries to operate the gate via a valid access control device, such as a remote control, etc. with Emergency Stop, the onboard buzzer will beep periodically for 30 seconds to confirm that the gate has been disabled using this feature



The emergency stop is typically used at a manned entrance so that security is not compromised with a would-be intruder possibly gaining access to the stop button. In a domestic situation you can set up one of your remote pushbuttons to operate the emergency stop without compromising your security

5.1.8. Positive Close Mode

Positive Close Mode is intended for applications where the gate must close fully against the gate end post for security reasons – such as ensuring proper contact of the switch on the gate that feeds power to the electric fence.

This feature operates only during the last few millimetres when the gate closes.



It is recommended that a rubber strip be fixed to the front edge of the gate to cut down the noise when the gate closes against the end post

5.1.9. Operator Run Profiles

The **D5-Evo**, **D10** and the **D10 Turbo** can be customised to your exact requirements using your LCD controller. The open and closing speeds can be independently set. Even the ramp up to full speed, ramp down to close speed and crawl distance before the gate stops can be adjusted. Please contact Centurion Systems (Pty) Ltd for more information on finding the configuration that is best for you.

5.1.10. Anti-crushing Sensitivity

The **D5-Evo**, **D10** and the **D10 Turbo** incorporate a sensitive electronic anti-crushing technology that activates if a person or vehicle obstructs your gate.

The operator will respond differently to obstructions depending on the Operating Standard (e.g. CE, UL325) you select. The typical response for an opening gate is to immediately stop and a closing gate will stop then immediately reopen.

Collision force can be set independently per direction of travel and can be set from minimum to maximum in five incremental steps. A sixth incremental step will disable collision sensing entirely and allow for maximum force – the motor will run until it stalls at which point a collision will be detected.

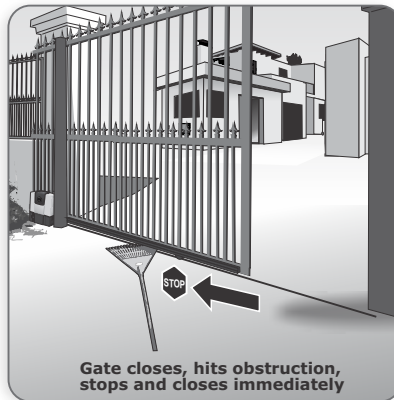

FIGURE 22



FIGURE 23



Step six should only be used if additional safety measures such as infrared beams and sensitive edges are present

- **5.1.10.1. Collision Count**

A counter monitors the number of collisions the gate experiences before it fully closes. If the number exceeds the default value of four, which can be adjusted in the Multiple Collisions Counter, the controller will shut down. The Status LED (page 20) will flash four times every second until a valid trigger is received

Please refer to Gate Status Indication (page 20) for more information on this diagnostic device

5.1.11. Infrared Safety Beam (optional but recommended)

- **5.1.11.1. Closing Safety Beams**

Closing Safety Beams provide additional protection against your gate closing on people, pets or vehicles

If the closing beam is broken while the gate is opening, it will continue to open. If the gate is open, the gate cannot be closed and if the gate is closing, it will stop and reopen

If you select the Autoclose (page 11) feature, the gate will remain open if the beam is broken and only close after the set Autoclose time has expired when the beam has cleared

You can use other protection devices like an inductive ground loop instead of an infrared beam, but loops are only sensitive to the presence of a vehicle (large metal objects) and provide no protection to people or other objects in the path of the gate.

Please contact Centurion Systems (Pty) Ltd for more information on suitable protection devices

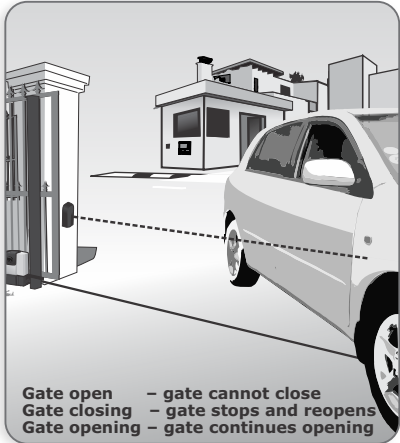

FIGURE 24

- **5.1.11.2. Opening Safety Beams**

These beams prevent your gate from opening if an object or person is in the way

If the beams are broken while the gate is closed, the gate will not open. If the gate is opening, it will stop then close. If the gate is closing, it will continue to close

Please contact Centurion Systems (Pty) Ltd for more information on suitable protection devices

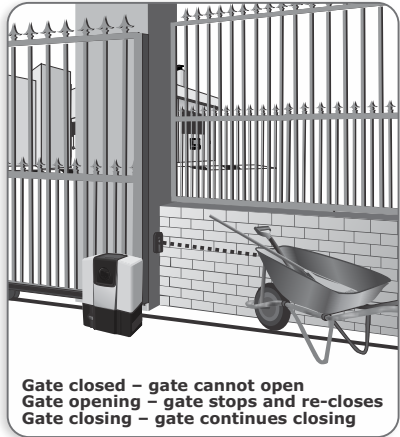

FIGURE 25

5.1.12. Intruder Detection Alarms* (a world first)

• 5.1.12.1. Ambush Alarm

Once activated, if the opening or closing beams are continuously interrupted for a predefined time, the Ambush Alarm will sound. Intruders often cover beams' lenses, thus breaking the beam, so your gate stays open after you have entered or left your property – but with the Ambush Alarm enabled you can be instantly alerted of any criminal activity.

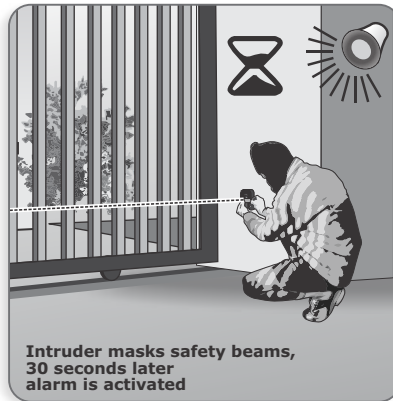

FIGURE 26

• 5.1.12.2. Break-In Alarm

If the closing beam on the outside of your property is broken, the Break-In Alarm will sound and continue until 30 seconds have passed since the beam is re-made.

Intruders will not be able to loiter outside your property as the Break-In Alarm will immediately alert you of their presence – and the noise of the onboard buzzer is often an effective deterrent. Optionally the alarm signal can be routed to an armed response company.



FIGURE 27

If the Ambush Alarm or Break-In Alarm is utilised, the system may be configured to operate one of the following outputs provided on the controller:

- Onboard buzzer – emits a continuous tone
- Pillar / Courtesy light contact
- Safety beam common
- Status LED output
- Auxiliary IO (which can be used to connect to a third party alarm and security company, or a CENTSYS G-SWITCH-22 device to alert you of the alarm via SMS)

It is typical to select only one of the alarm features.

* Requires infrared gate safety beams to be installed

Features
and
functions

5.1.13. External Gate Status Indication

A LED (Light Emitting Diode) mounted on your intercom allows you to view the position of your gate and the condition of the battery and power supply from the safety of your home. The different signals of the LED are described below:

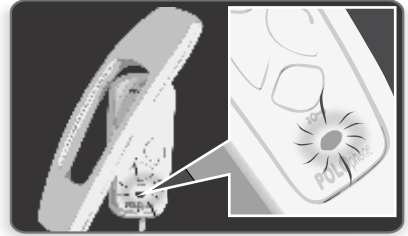

FIGURE 28

Off	Gate is closed
On	Gate is partially or fully open
Continuous slow flash	Gate is opening
Continuous fast flash	Gate is closing
One flash every two seconds	Courtesy (Pillar) lights on
Two flashes every two seconds	No mains present
Three flashes every two seconds	Battery voltage is low
Four flashes every two seconds	Multiple collisions have occurred



If you choose not to fit a Gate Status Indicator, the Status LED on the controller can also be used for trouble-shooting.

5.1.14. Courtesy (Pillar) Light Timer (optional feature)

Courtesy (Pillar) Lights can be connected through the controller if a 220-240V power supply is available at the gate. The lights will switch on every time the gate is given a signal to operate and stay on for an adjustable period of one second to ten minutes (in increments of one second) then automatically turn off.

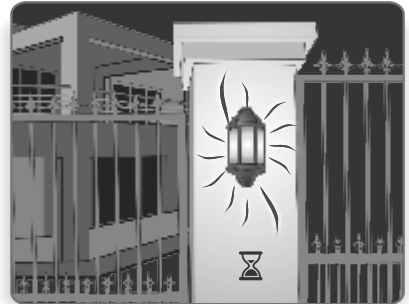

FIGURE 29

The purpose is to bathe your entrance with light when you open the gates and increase your security as you drive into your property – it also saves electricity as the lights only come on when you use the gate motor.

Using the Pedestrian Opening feature will cause the Courtesy (Pillar) Lights to flash three times before the gate opens.

- **5.1.14.1. Courtesy (Pillar) Light Control**

The Courtesy (Pillar) Lights can be switched on from inside your home or office by connecting a pushbutton to the **D5-Evo, D10 or D10 Turbo** controller.

For your safety this pushbutton switches only low-voltage signals.

Press and release the button for the lights to switch on for the defined period then switch off automatically. Press and hold the button for three to four seconds for the lights to stay on permanently, until you push the button again. If the Gate Status Indicator is fitted to the intercom handset, the LED will flash once every two seconds to indicate that the lights are on permanently

This feature can also be operated using your remote control. Simply set one of the spare buttons on the transmitter to switch your Courtesy (Pillar) Lights on and off.

Please refer to Onboard Multichannel Receiver (page 22) for more information on the various functions you can operate with your remote control

Low-wattage, 12V DC light fittings are also readily available and can be connected to the system, drawing power directly from the battery. However, please ensure that the power drawn by the lights and motor does not exceed the recharge rate of the battery. Larger charger units can be fitted to cope with the additional load – contact your gate automation specialist or Centurion Systems (Pty) Ltd for more info.

- **5.1.14.2. Courtesy (Pillar) Lights act as Warning Light**

For additional safety, the Courtesy (Pillar) light output can be configured to act as a warning light before the gate operates and while the gate is moving.

Contact your gate automation specialist or Centurion Systems (Pty) Ltd for more details on the different warning light modes

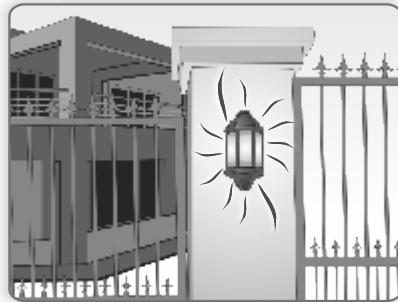

FIGURE 30

- **5.1.14.3. Pre-open and pre-close delays**

If you make use of the Warning Light feature, you can set your gate to have a slight delay before it opens or closes to allow the light to warn pedestrians or vehicles that the gate is about to move

The pre-open and pre-close delays can be independently set and also independent of enabling the warning light feature referred to above

5.1.15. Onboard Multichannel Receiver

The **D5-Evo**, **D10** and **D10 Turbo** controllers are supplied standard with a multichannel receiver compatible with CENTSYS' secure code-hopping remote controls. The receiver will allow any combination of the different inputs (such as Trigger, Pedestrian, Holiday Lockout, etc.) to be operated from a single multi-button remote control.

You can artificially increase the number of buttons of a CENTSYS multi-button remote control by using a two button combination. One of the buttons is used as a shift button to allow the other buttons to be used again in combination with this button. Press and hold the shift button and then press one of the other buttons to create a new button. The shift button cannot be used as a button on its own; it must always be used in combination with another button.

Use of the shift key principle allows a three button transmitter to gain an extra button and operate four functions and a four button transmitter gains two extra buttons and can operate six functions.

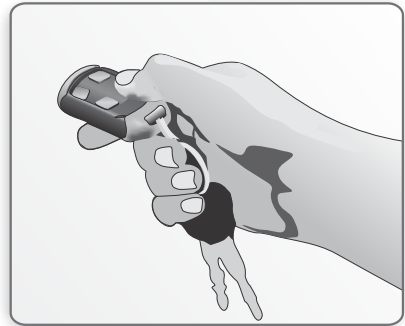

FIGURE 31

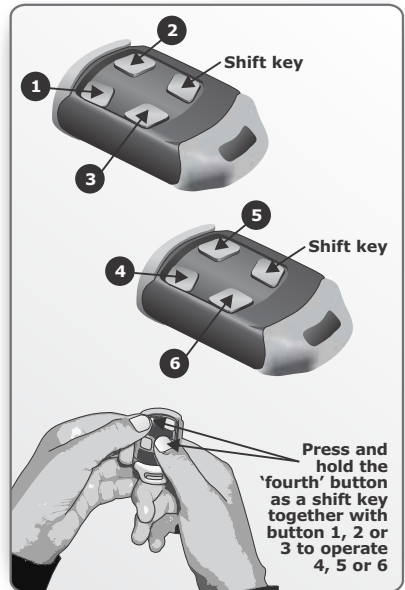

FIGURE 32

This is quite handy if you'd like to control additional devices from a single multi-button remote control, for example, your garage doors if they are equipped with CENTSYS code-hopping receivers.

However it's also important to note that other devices cannot be activated with the new shift button, only the **D5-Evo**, **D10** and **D10 Turbo** (and other CENTSYS operators that are equipped with an onboard receiver) are able to recognise the shift button signals. Using a shift button also prevents you from enabling functions like Holiday Lockout Mode by accident because you have to use both hands to press the two button combination.

Another function provided with this receiver is the ability to record the memory location of each remote control, mapping this to the name of the owner of the remote (if recorded). This allows any transmitter that is lost or stolen to be selectively erased from the system without affecting any of the other remotes installed.

It is also possible to erase the functions of certain buttons on a remote control if they're no longer required. Alternatively, the functionality of certain buttons can be changed to trigger different functions.

At any stage remote controls can be selectively added, deleted or edited within the system.

Contact your gate automation specialist or Centurion Systems (Pty) Ltd for assistance.

5.1.16. ChronoGuard Timer (a world first)

ChronoGuard™ (a world first) is a powerful multichannel timer feature which has been added to the **D5-Evo, D10** and **D10 Turbo** controllers. A Real Time Clock and Calendar (RTC) lets you set the following features to operate automatically or be prevented from operating (time-barred) during any Time-period you choose:

- Trigger (TRG) (auto activation and time-bar[⊛])
- Free-exit (FRX) (auto activation and time-bar[⊛])
- Pedestrian opening (PED) (auto activation and time-bar[⊛])
- Holiday Lockout (LCK) (auto activation and time-bar[⊛])
- Closing Beam (IRBC) (auto activation only)
- Courtesy (Pillar) Light control (AUX) (auto activation and time-bar[⊛])
- Courtesy (Pillar) Light relay (time-bar only[⊙])
- Auxiliary output* (auto activation and time-bar)

⊛ It is possible to time-bar the operation of the device physically wired to this feature and/or the same feature controlled via the radio receiver.

* Spare output, which via a relay board can drive a variety of external devices such as sprinkler system, fountain etc.

A Time-period can be a once off event, or can be set to repeat on a weekly or annual basis. The weekly repeat can be chosen to occur on every day of the week, weekdays only, weekends only, or any specific day. The minimum duration of a Time-period is one minute – and you can set 100 different Time-periods. The "Tp" icon will appear on the display to indicate that a Time-period is active.

You can even set up different conditions by combining Time-periods as well as set up exclusions (once off Time-periods when the auto activation or time-bar period must be ignored) so your gate will automatically open at certain times on weekdays, but will know not to open on a public holiday.

• **5.1.16.1. Some examples of how to use ChronoGuard:**

- Pillar / Courtesy Lights could be set to switch on at 20:00 in combination with Holiday Lockout Mode so your driveway would be lit up and locked down to keep you safe at night.



FIGURE 33

- Time-bar prevents something from switching on or being activated – so use it to turn off functions like Courtesy / Pillar Lights to save electricity during the day. Or de-activate the free-exit loop at the exit to your premises after hours and over weekends.



FIGURE 34

Time-bar can also be used to limit access. For example, your staff can get in on weekdays – but will be locked out over the weekend or on public holidays for added security. However, there is only one group that can be set up per input. So, if you want your gardener's remote to be time-barred for a certain period and your maid's to be barred for a different Time-period, you'll have to set the gardener's remote to open using one input (like the operator) and the maid's remote to trigger another input (like the keyswitch).

- If your factory is particularly busy during certain hours of the day from Monday to Friday, set your operator to keep the gates open during these times to allow for quick traffic flow. During any other hour, or over the weekend or public holidays, you'll have to use your CENTSYS access control device (keypad, proximity reader etc) to get in.

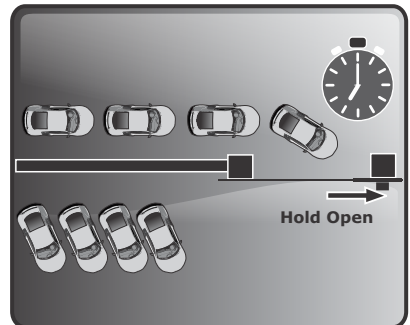

FIGURE 35

5.1.17. Battery Low Protection

In the event of a power failure, energy is drawn from the battery but not replaced. Battery Low Protection will shut off the gate system to prevent running the battery flat when the battery voltage drops below:

- **D5-Evo** – 10.5 volts
- **D10/D10 Turbo** – 21 volts

The Gate Status Indication LED will flash three times every 2 seconds and the controller LCD will state "Battery Low".

The gate will complete its current cycle, close and then shut down until the battery voltage has recovered.

If you see the Battery Low signal, check that the power circuit feeding the gate motor is switched on otherwise contact your local gate automation specialist or Centurion Systems (Pty) Ltd for assistance.

6. Additional features

6.1. Battery saver

In the event of a Battery Low shutdown, only the motor will stop drawing current – the controller, infrared beams and any other peripheral device will continue to draw power and flatten the battery, however, at a much slower rate.

An optional low cut-out switch (product code CP107)* totally disconnects the battery and protects it from being fully discharged and potentially damaged.

Contact your gate automation specialist or Centurion Systems (Pty) Ltd for further details.

* Currently only available for the D5-Evo not the D10/D10 Turbo



FIGURE 36

6.2. Solar power supply

6.2.1. D5-Evo

A solar panel can be used to charge the battery instead of the conventional charging circuit. A 20 Watt panel will provide enough power for 20 operations (less if 12V DC security lights are fitted) of an average gate.

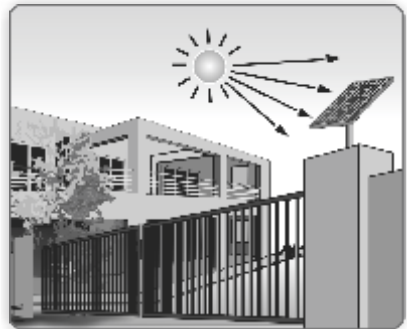

FIGURE 37

You will need to fit a deep-cycle low-maintenance battery (minimum 35Ah) in order to provide sufficient back-up capacity during days of poor weather. The charger supplied with the standard **D5-Evo** system must also be replaced with a high efficiency solar regulator.

These are typical values for Southern Africa. Contact Centurion Systems (Pty) Ltd or your gate automation specialist for details on what solar panel to select in your area.

6.2.2. D10 and D10 Turbo

It is possible to adapt in the **D10** as well as **D10 Turbo** for solar charging; however, typically 2 x 20W panels wired in series with the 24V battery supply will be required. Contact Centurion Systems (Pty) Ltd or your gate automation specialist for details

6.3. Lightning Protection

The **D5-Evo**, **D10** and **D10 Turbo** controllers come standard with on-board lightning protection – but please make sure that an adequate earth is installed for this to function properly.

Please contact Centurion Systems (Pty) Ltd for more information.

Lightning damage is not covered under the normal warranty of the equipment.

**Additional
features**

7. Basic maintenance

CENTSYS operators are designed to be maintenance-free. However, there are some basic checks that should be carried out regularly, (every six months). These checks will increase the long term reliability of the system and prevent erratic operation of your gate.



WARNING! Isolate mains supply as well as disconnect the battery before cleaning or working on the equipment.

General

- Keep the track clear of stones, dirt and obstructions
- Ensure that all rollers run freely
- Put the operator into Manual Mode and check that the gate runs freely on its rail and does not catch or foul against the walls or pillars
- Ensure that the gate wheels and guide-rollers are rotating freely and are not worn. In high-volume applications it will be necessary to replace these components regularly
- Ensure that the rack is properly secured to the gate and that it does not press down onto the operator pinion at any point along its travel
- Keep shrubs and vegetation clear of the motor and rack
- Check that the key still operates the camlock - spray with lubrication if necessary
- Keep the inside of the motor housing clear of insects and dust

Battery

CENTSYS operators, which are fitted with maintenance-free lead acid batteries, should provide at least three years of normal service life.

For sites utilising an external large capacity (+/-35Ah) low maintenance battery, ensure that the level of liquid (electrolyte level) is correct.

In all instances check for corrosion of the battery terminals. Clean and apply copper based grease as necessary.

Charger

The **D5-Evo**, **D10** and **D10 Turbo** operators have chargers separate to the main controller. In the case of product malfunction, the charger fuse should be checked, but only by a qualified electrician.

Always isolate the mains supply to the operator before attempting to remove and check the fuse.

Check the "Mains Present" icon on the main diagnostic screen or switch to the battery charger diagnostic screen and check the charger voltage – right hand value. This should indicate, 13.8V for the **D5-Evo** and 27.6V for the **D10** and **D10 Turbo**. Each charger has a red light (LED) to indicate mains supply.

Gearbox Oil Level

Gearbox Oil Level Check the oil level as described in the Lubrication section of the Installation Manual. Should the installation manual be unavailable, please refer to the online manuals on our website, www.centsys.co.za. Alternatively, please contact your Centurion Systems (Pty) Ltd installer for assistance.

8. Diagnostics

Depending on the type of fault or condition of the motor, audible feedback will be given via the onboard buzzer. Listen out for this and refer to the table below:

The different conditions are given in order of precedence.

Break-in alarm – if the safety beams have been broken with this feature set, the buzzer will emit a continuous tone for 30 seconds

Ambush alarm – if the safety beams have been broken with this feature set, the buzzer will emit a continuous tone until the safety beams have been cleared

Battery low – Buzzer will emit three beeps every two seconds for 30 seconds. Refer to section, Battery Low

Multiple collision – Buzzer will beep periodically until condition is cleared. Refer to section, Anti-crushing, collision count

Holiday lockout – If the Holiday Lockout has been enabled, when triggering to operate the gate, the gate will not operate but the buzzer will emit one beep periodically for 30 seconds

Emergency stop – If the Emergency stop button has been activated, the buzzer will emit buzzer will emit one beep periodically for 30 seconds

Time-barring - if a time-barred input or remote control is operated during a time-barring period, in addition to the gate not reacting to the input being activated or the remote control, the buzzer will emit one beep periodically for 30 seconds

Mains failure – If the mains supply to the charger has failed the buzzer will emit two beeps every two seconds for 30 seconds

Safety beam broken – if something in the path of the beams the buzzer will emit one beep periodically for 30 seconds

Safety beam failure – if the safety beams are not operating the buzzer will emit five beeps periodically for 30 seconds (beams test circuit must be enabled)

Contact your gate automation specialist or Centurion Systems (Pty) Ltd for further assistance.



WARNING! Do not attempt to repair the unit yourself. Any work performed by unauthorised personnel may void the warranty.

Diagnostics

9. Specifications

Technical specifications

Technical data	D5 - Evo	D10	D10 Turbo
Input voltage	220-240V AC +/-10%, 50Hz*	220-240V AC +/-10%, 50Hz*	220-240V AC +/-10%, 50Hz*
Motor voltage	12V DC	24V DC	24V DC
Motor power supply	Battery driven** – 2A charger	Battery Driven** – 2.0A charger	Battery Driven** – 2.0A charger
Push force - rated	17kgf	30kgf	15kgf
Gate speed (varies with load)	18 - 22m/min	22 - 26m/min	40 - 50m/min
Duty cycle - mains present	50%*†	45%*†	25%*†
Daily operations – max	150*	750*‡	750*‡
Gate mass - max	500kg	1000kg	Varies with speed [▲]
Onboard receiver specification	CENTSYS code-hopping multichannel, 433MHz, capacity - 500 transmitter buttons	CENTSYS code-hopping multichannel, 433MHz, capacity - 500 transmitter buttons	CENTSYS code-hopping multichannel, 433MHz, capacity - 500 transmitter buttons

D10 Turbo maximum operating speed for corresponding gate mass

Gate mass (kg)	Operator max. running speed (m/min)
240	50
300	40
400	36
500	32
600	29
700	27
800	25
900	24
1000	23

* Can operate off a solar supply, consult Centurion Systems (Pty) Ltd for assistance

** 7Ah battery (can be upgraded for longer power failure autonomy)

* Based on a push force of less than 50% of rated

† Based on 25°C ambient temperature and unit not in direct sunlight

‡ With brush replacement interval of two years

▲ See D10 Turbo Maximum Operating Speed for Corresponding Gate Mass Table

10. 24 Month product warranty



You can register your product(s) online at www.centsys.com.au which will assist you in keeping a record of your date of purchase or installation, serial numbers, etc.

This information may come in handy for future reference to help you in the event of a warranty claim, or to remember your installer's details, or for any other future reference needs that may arise.

All CENTSYS products are manufactured with extreme care, thoroughly inspected and tested. All CENTSYS products are warranted against faulty materials and workmanship for a period of 24 months from the invoice date of the product or 26 months from the manufacturing date (as shown on the serial number label of the operator), whichever expires first.

The warranty will cover the repair or replacement, at the discretion of Centurion Systems (Pty) Ltd, of such faulty materials or parts free of charge provided that the equipment is returned to our workshop. The workmanship of the installation of the products carried out by any third party is specifically not covered under this warranty (please consult with your installer about their workmanship warranty terms and conditions). For equipment not of CENTSYS' manufacture the warranty as supplied by the original manufacturer will apply.

No claims whatsoever will be recognised under the terms of this warranty which pertain to damage, injury, cost or expense, suffered by persons and / or to property, which either directly or indirectly arise out of any one of the following occurrences:

- a) Failure to install the product in accordance with the installation instructions provided by Centurion Systems (Pty) Ltd.
- b) Failure to abide by the safety instructions provided by Centurion Systems (Pty) Ltd.

This warranty will not apply to any equipment which:

- a) Has not been installed in accordance with the installation instructions provided.
- b) Has been subject to misuse or which has been used for any purpose other than that designed for by the manufacturers.
- c) Has damage caused as a result of handling during transit, atmospheric conditions (including lightning), insect infestation, power surges or other forces outside of the control of Centurion Systems (Pty) Ltd.
- d) Has been repaired by any workshop and / or person NOT previously authorised by Centurion Systems (Pty) Ltd.
- e) Has been repaired with components not previously tested, passed or authorised by Centurion Systems (Pty) Ltd.

**24 month
product
warranty**

11. Optional extras

CENTSYS infrared Safety Beams

Always recommended on any gate automation installation

SMARTGUARD keypad

Cost-effective and versatile keypad, allowing for access to pedestrians, armed response companies, etc.

SOLO/Lattice Proximity Access Control System

Proximity reader, allowing for access to both pedestrians and vehicles, while offering a higher level of security than a keypad

Pedestrian keyswitch

Allows for pedestrians to partially open the gate using a key

POLOphone Intercom System

Allow visitors to communicate with residents in order to gain access to the property

POLOview Surveillance System

Enhances the POLOphone to provide CCTV at the gate

Theft-resistant Cage

Retro-installable steel cage that increases the resistance of the operator against theft



FIGURE 38

Optional
extras

Notes

Notes

Lined area for writing notes.



Notes

Notes

Lined area for writing notes.



Notes

Notes

Lined area for writing notes.





 facebook.com/CenturionSystems

 YouTube.com/CenturionSystems

 [@askCenturion](https://twitter.com/askCenturion)

Subscribe to the newsletter: www.CentSys.com/Subscribe

Call: 1300 CENTSYS (1300 236 879)
After Hours International Technical Support Call Centre
+27 11 699 2481 (16:00 to 02:00 - Australian Eastern Time)

www.centsys.com.au

E&OE Centurion Systems (Pty) Ltd reserves the right to change any product without prior notice

All product and brand names in this document that are accompanied by the ® symbol are registered trademarks in South Africa and/or other countries, in favour of Centurion Systems (Pty) Ltd, South Africa.

The CENTSYS logos, all product and brand names in this document that are accompanied by the TM symbol are trademarks of Centurion Systems (Pty) Ltd, in South Africa and other territories; all rights are reserved. We invite you to contact us for further details.



SAP: CP70SLIDV4AU 29062018
CODE: 1010.D.01.0010_29062018