

# INSTALLATION MANUAL:

## **MOTOR-REDUCER: XNODO**

In the motor-reducer XNODO 2 parts are distinguished: In one these parts, we have the electric motor and in the other, the reduction group. The XNODO motor-reducer is suitable for the actioning of gates for opening doors, this kind of reducer is particularly suitable for applications of very large pillars where physical obstruction doesn't allow the use of traditional actuators. The XNODO irreversible motor-reducer disposes of a mechanical unblocking system which allows the use of the gate even if electricity is missing. Limit-switch in opening and closing, anchor plate and carter are included.

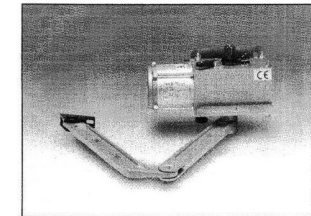
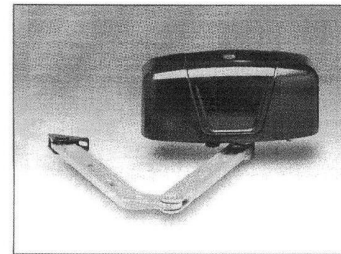

TECHNICAL FEATURES		
Supply voltage	230V -50+60 Hz	24Vdc
Absorption	1,3 A	1 A
Condenser	12,5 Mf	/
Motor rotation speed	1400 RPM	1800 RPM
Working temperature	-20°c + 55°c	
Lubrification	Permanente	
Weight	8 kG.	
Thermal intervention	110° c	/



Via Circolare p.i.p. sn  
65010 Santa Teresa di Spoltore (PE) - ITALY  
Tel. 085-4971946 - FAX 085-4973849  
www.vdsproduction.it - vds@vdsproduction.it



**WARNING!!** Before installing, thoroughly read this manual that is an integral part of the pack

**Our products if installed by qualified personnel capable to evaluate risks, comply with norms UNI EN 12453, EN 12445**



The CE mark conforms to European directive EEC 89/336 + 92/31 + 93/68 D.L. 04/12/1992 N. 476.

## PRELIMINARY WARNINGS

Make sure that the gate has been installed correctly with the hinges on the same vertical axel, activate the gate manually, for all the stroke and make sure that no abnormal resistances are present.

## INSTALLATION

To install the motor-reducer corretly follow as carefully, as possible the instructions listed below, using accessories given with motor-reducer.

1. Check instructions in the preliminary warning
2. Regarding the gate's door opening angle: place anchorage bracket "A" of the motor on the stable part of the gate, ( remember the total obstruction of the motor-reducer and carter) in a way that during the opening stroke the door doesn't slam the motorization. Place anchorage bracket "A" of the motor about 50mm. higher than the assembling point of the anterior binding "B" (moving part of gate).
3. Fix, according to the established figures bracket "A" of the motor using the 4 insert with steel expansion for walled pillars, for metal pillars fix the bracket by welding. Fix the anterior binding "B" to the stable part of the gate. In both cases ceck the alignment with a level.
4. Insert the motor-reducer (limit-switch on top) on bracket "A" and fix it with 4 tie rods and nuts given.
5. Insert the arm straightly with the ferrule on the transmission joint of the motor-reducer and fix with appropriate screws.
6. Place the curved arm straightly in a way that it coincides with the 2 holes, so join with given screws without locking completely.
7. Place the other end of the curved arm so that it meets with the hole of the anterior binding "B" (stable part of gate) and fix with the screw and nut given without locking completely.
8. Manually activating the gate door, adjust by using the 2 cams the operation of Limit-Switch in opening and closing.

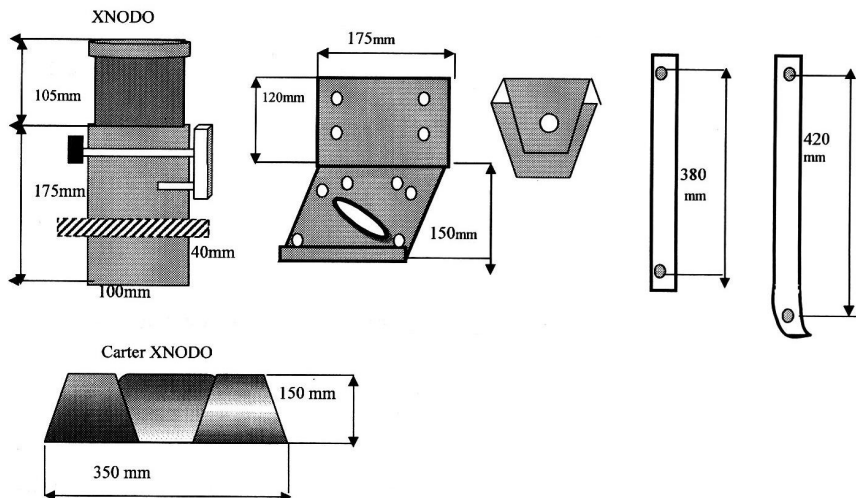

## Manual release

- In case of lack of electricity, can unlock it manually:
- Remove the plastic cap.
- For unlocking: insert the hex key into the hole, grabbing the key and rotate clockwise.
- To block: with hexagonal key rotate counterclockwise

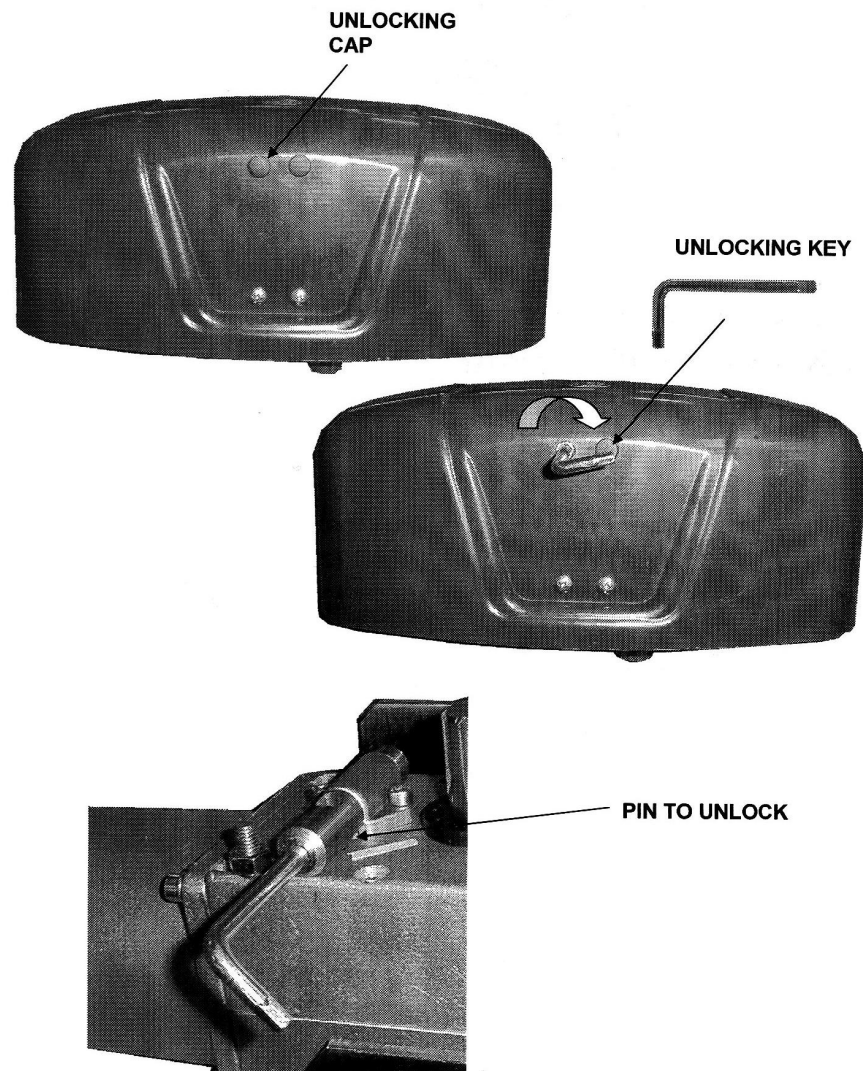

## LIMIT-SWITCH ADJUSTMENT

XNODO motor-reducer is given with 2 micro-switches controlled by 2 adjustable cams in order to activate the limit-switch in opening and closing Photo2: The user should: Unblock the motor-reducer and position the door (opening) near a stop bead and let the cam turn until you hear the micro-switch click, then bolt stopping screws. Repeat operation with the other cam the other way (closing). Block the motor-reducer, the above mentioned micro-switches must be connected to the electronic switch-board.

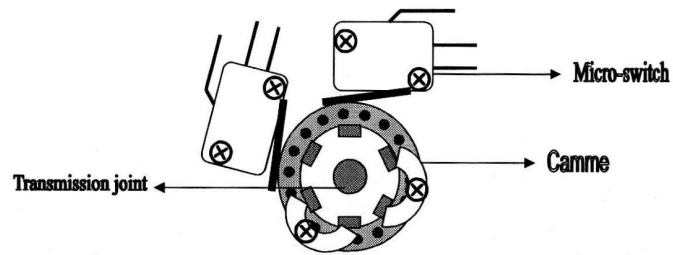

Instructions for the use of the motor-XNODO:

Length max of door in mt.	Maximum weight in Kg.
2	800
2,5	600
3	400

Indicative figures for the installation of motor-reducer

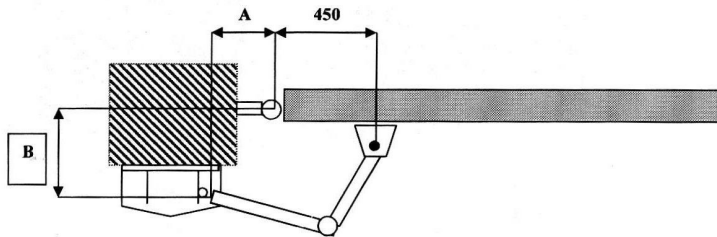

A	B							
	90mm	110mm	150mm	200mm	250mm	300mm	350	
110mm	120°	120°	110°	105°	105°	100°	95°	
130mm	120°	120°	120°	115°	110°	105°	100°	
150mm	125°	120°	115°	115°	110°	105°	100°	

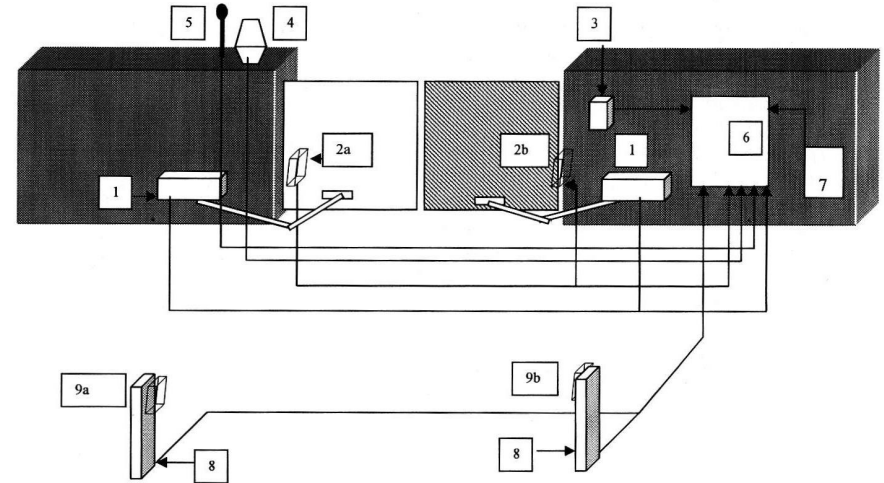

- 1- Motor-reducer Xnodo : wire 4x1 –Yellow/green = Ground
- 2b- Sending External photocell – wire 2x1 mm
- 2a- Receiving External photocell – wire 4x1 mm
- 3- Selector – wire3x1
- 4- Flashing lamp – wire 3x1,5
- 5- Aerial/Antenna – wire 1xRG 58
- 6- Electronic board with receiving radio
- 7- Differential switch – wire3x1,5 – 16A – threshold 0,030A
- 8- Pillars for photocells
- 9a- Sending internal photocell – wire 2x1 mm
- 9b- Receiving internal photocell – wire 4x1 mm

## TROUBLESHOOTING

PROBLEM	PROBABLE CAUSE	SOLUTION
On giving a command with the remote control or with the key-switch, the gate doesn't open or the motor doesn't start	230 volt mains voltage absent	Check master switch
	Emergency STOP present	Check for any STOP selectors or commands. If not used, check jumper on STOP contact input on the control board
	Fuse blown	Replace with one of same value.
	Power cable of motor or motors not connected or faulty.	Connect the cable to appropriate terminal or replace.
	The photocell is not functioning or the beam is interrupted	Check the connection, remove any obstacle across the beam
On giving a command with the remote control, the gate doesn't open but works with the key command	The remote control has not been memorised or the battery is flat	Carry out the remote control learning procedure on the radio receiver or replace the battery with a new one.
On giving a command, the flashing warning light works slowly and the light is dim	2 A fuse blown	Replace with one of same value
The gate starts, but stops immediately	The force of the motor or motors is insufficient	Modify the value with the FORCE trimmer on the control unit
On giving a command, the motor starts, but the gate does not move	There is an obstacle in front of the wings, the hinges are blocked or the motor anchorage bracket or brackets have come loose	Remove the obstacle from the wings, restore the hinges, replace or lubricate them. Fasten the motor bracket
	The electric lock, if present, does not work	Check if the electric lock connected or lubricate it
One wing opens and the other closes	The connection is not correct	Invert the connection of the cable of the motor which rotates in the wrong sense

**N.B. - If the problem persists, contact your Retailer or the nearest Service Centre**

## SAFETY PRECAUTIONS

These warnings are an essential, integral part of the product and must be given to the user. They provide important indications on the installation, use and maintenance and must be read carefully. This form must be preserved and passed on to subsequent users of the system. The incorrect installation or improper use of the product may be dangerous.

## INSTALLATION INSTRUCTIONS

The installation must be performed by professionally skilled personnel and in compliance with current local, state, national and European legislation.

Before beginning the installation, check the integrity of the product.

The laying of cables, electrical connections and adjustments must be workmanlike performed. The packing materials (cardboard, plastic, polystyrene, etc.) are a potential hazard and should be disposed of correctly and not left within reach of children.

Do not install the product in potentially explosive environments or environments disturbed by electromagnetic fields. The presence of inflammable gases or fumes is a grave danger to safety. Set up a safety device for overvoltage, a disconnecting and/or differential switch suitable for the product and conforming to current standards.

The manufacturer declines any and all responsibility for product integrity, safety and operation in the event incompatible devices and/or components are installed.

Solely original spare parts should be used for repairs and replacements.

The installer must provide all the information relating to the operation, maintenance and use of the individual parts, components and system as a whole.

## WARNINGS FOR THE USER

Read the instructions and enclosed documentation carefully.

The product must be used for the express purpose for which it was designed. Any other use is considered improper and therefore hazardous. In addition, the information given in this document and in the enclosed documentation may be subject to modifications without prior notice. It is given as an indication only for product application. The company declines any responsibility for the above.

Keep products, devices, documentation and anything else provided out of reach of children. In the event of maintenance, cleaning, breakdown or faulty operation of the product, cut off the power and do not attempt to operate on the product. Contact solely the professionally skilled personnel responsible for these operations. Failure to adhere to the above indications may be dangerous.

**The data and images are for guidance only  
VDS reserves the right to change at any time characteristics of the products described  
in its sole discretion, without notice.**