

- I** Ruota in nylon Ø 33 piana a 1 cuscinetto
- UK** Plain nylon wheel Ø 33 - 1 bearing
- D** Nylon Rolle Ø 33 - 1 - Lager
- F** Roue nylon Ø 33 - 1 roulement
- E** Rueda nylon 1 cojinete Ø 33

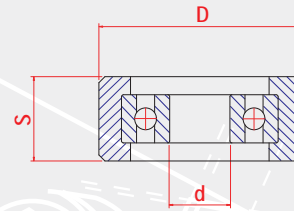

ARTICOLO-ARTICLE	D	d	S			€
Riferimento-Reference	Ø	Ø	mm	N°	kg	X 1
RN 33	RP 33 14 CX	33	10	14	150	3,6

- I** Ruote in nylon piane con cuscinetto
- UK** Plain nylon wheels with bearing
- D** Nylonrolle mit Lager
- F** Roue en nylon avec roulement
- E** Ruedas nylon planas con cojinete

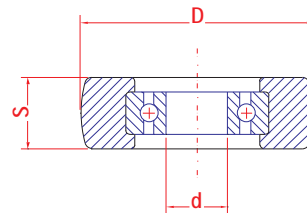

ARTICOLO-ARTICLE	D	d	S			€
Riferimento-Reference	Ø	Ø	mm	N°	kg	X 1
RN 40	RP 40 15 CX	40	12	15	150	4,7
RN 48	RP 48 15 CX	48	12	15	100	4
RN 60	RP 60 19 CX	60	17	19	50	4,7
RN 65	RP 65 19 CX	65	17	19	50	5,3
RN 65 F 20	RP 65 19 1X	65	20	19	50	5,9
RN 70	RP 70 19 CX	70	17	19	50	5,8
RN 80	RP 80 23 CX	80	20	23	50	5,6
RN 80 F 25	RP 80 23 1X	80	25	23	30	6,5

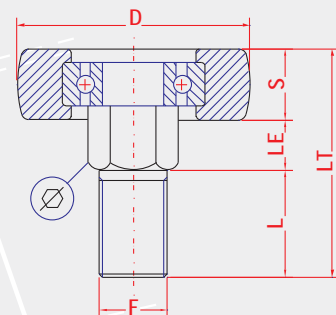
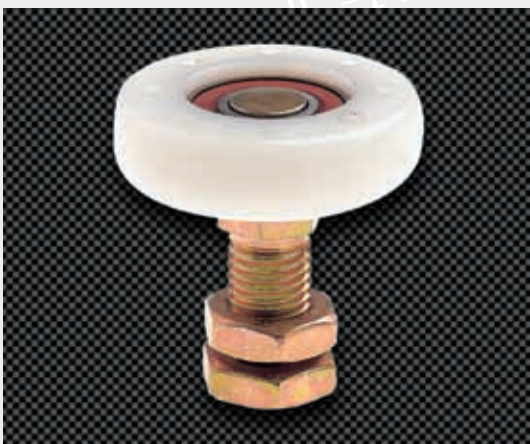

- I** Ruote in nylon piane con cuscinetto con perno filettato
- UK** Plain nylon wheels with bearing & threaded pin
- D** Nylonrolle mit Gewinbolzen mit Lager
- F** Roue en nylon avec roulement et axe fileté
- E** Ruedas nylon planas con cojinete con tornillo fileteado

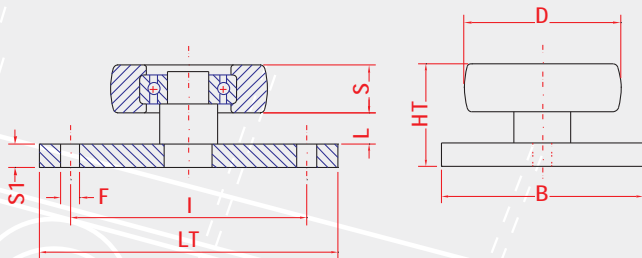

ARTICOLO-ARTICLE	D	S	FxL		LE	LT			€
Riferimento-Reference	Ø		mm	N°	mm	mm	kg	X 1	
RNF 40	RP 40 15 FO	40	15	M14x40	17	8	64	50	6,6
RNF 48	RP 48 15 FO	48	15	M14x40	17	8	64	40	5,6
RNF 60	RP 60 19 FO	60	19	M20x40	22	13	72	20	6,2
RNF 65	RP 65 19 FO	65	19	M20x40	22	13	72	20	6,5
RNF 70	RP 70 19 FO	70	19	M20x40	22	13	72	20	6,8
RNF 80	RP 80 23 FO	80	23	M20x40	22	10	73	10	4,2

- I** Ruote in nylon plane con cuscinetto e piastra
- UK** Plain nylon wheels with bearing and plate for special guides
- D** Führungsrolle aus Nylon mit Lager und Montageplatte
- F** Roue en nylon avec roulement et plaque pour guide spécial
- E** Rueda nylon plana con placa y cojinete



ARTICOLO-ARTICLE		D	S	BxS1	L	HT	F	I	LT			€
Riferimento-Reference		Ø	mm			Ø	mm		N°		X 1	
RNP 40	RP 40 15 P0	40	15	30x6	10	31	8	90	120	40	9,2	
RNP 48	RP 48 15 P0	48	15	30x6	10	31	8	90	120	30	7,2	
RNP 60	RP 60 19 P0	60	19	30x6	10	35	10	90	120	20	6,7	
RNP 65	RP 65 19 P0	65	19	30x6	10	35	10	90	120	20	6,9	
RNP 70	RP 70 19 P0	70	19	30x6	10	35	10	90	120	20	7,1	
RNP 80	RP 80 23 P0	80	23	50x8	10	41	10	90	120	10	6,6	