

PAN320KPH

Manual

VER: A0





CATALOGUE







Precautions	1
Parts in the package	1
Names of each part and Functions	2
Operation Instructions	3
Wiring	3
Installation Instructions	4
How to correct the usual faults	4
Specification	5

Please read this manual carefully before installation and operation to avoid any damage or loss.

Precautions

<p>WARNING</p> <p>(1) Only professional engineer is qualified for the wiring work.</p> <p>(2) Do not disassemble or replace any parts without authorization from the manufacturer.</p> <p>(3) Except products approved by the manufacturer, do not match it with products of other manufacturers.</p> <p>(4) To avoid fire and electric shock, do not expose it to rain or humidity.</p> <p style="text-align: center;"></p>	<p>CAUTION</p> <p>(1) Keep the surface clean. Do not wash it with water directly. Do not wipe with chemical solvent like thinner, benzene and petrol.</p> <p>(2) Keep the device away from rain and humidity.</p> <p>(3) Do not install it at place of high temperature or under direct sunshine. Standard operation temperature is $-10^{\circ}\text{C} \sim 50^{\circ}\text{C}$.</p> <p>(4) Do not smash or strike the device with fists or other sharp and hard objects, nor hit other articles with it.</p> <p>(5) Installation in strong magnetic field area is strictly prohibited.</p> <p>(6) Installation near broadcast station or antenna may cause signal interference</p> <p style="text-align: center;"></p>
--	--

Parts in the package :

Outdoor station		Indoor Station			
Other Accessories	Bracket 	Manual 	Adaptor 	Screws 	

Names of each part and Functions

Outdoor Station

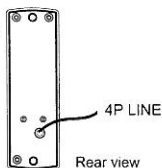
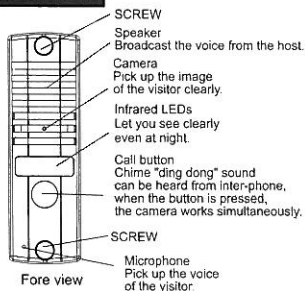

4P LINE FUNCTION DESCRIPTION:

Brown (R1)	: VIDEO
Black (R2)	: GND
White (R3)	: AUDIO
Red (R4)	: VCC

Indoor Station

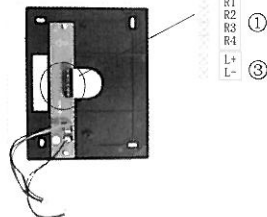
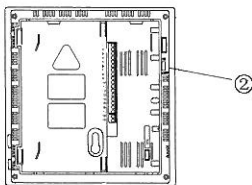
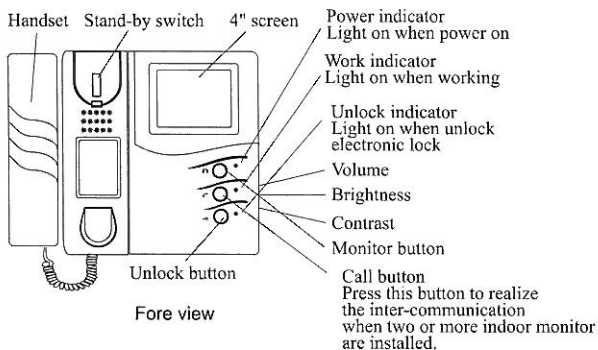

- ①、 Four terminals: R4、 R3、 R2、 R1 of indoor station connect separately to terminals R4、 R3、 R2、 R1 of outdoor station.
- ②、 Image impedance matching switch of 75 Ω ;
- ③、 Two terminals: L+、 L- connect to E-lock+ and E-lock- separately.

Operation Instructions

Visitor calling:

- 1.A visitor presses the Call Button on the outdoor station,
A Ding-Dong chime is heard which verifies a calling .
- 2.The visitor then talks hands-free after you answer the call.

Monitor Station:

- 1.A chime sounds and the visitor appears on the Monitor Screen automatically.
- 2.Pick up the Handset to talk with the visitor.
- 3.Hang up the Handset and the Monitor returns to stand by mode.

Monitoring:

Press Monitor Button, You will see the Camera ' s field of view for 90 seconds.

Wiring:

1. If 3 monitors are installed, image impedance switch must be switched on for the third monitor only.
2. For clearer picture, please use RG59 75Ohm coax cable for connecting terminal No.1(video)and No.2(ground) between outdoor station and indoor monitor.
- 3.How to connect with electronic lock:
L+,L- are terminals for connecting Electronic Lock.

Recommended cable:

- (1). 1 x 14/020 4 Core security cable (shielded preferred)
- (2). 1 x 0.75mm² Figure 8 cable (for latch)
- (3). This is recommended for a wiring distance of <50m.
- (4). 0.75mm² Figure 8 cable for electronic lock connection (distance <50m)
- (5) Latch requirement :12VDC <500mA

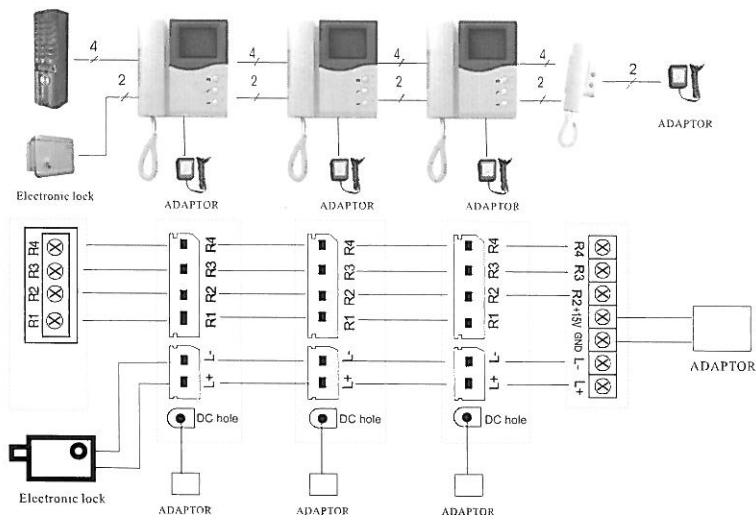

Installation Instructions

☆ Outdoor Station

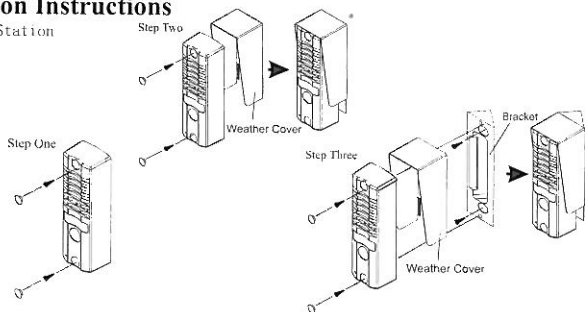

☆ Indoor Station

1. Fasten little PCB, which have some terminals on it to the bracket.
2. Connect the 4-cord wire from the indoor station to the outdoor station.
3. Screw the bracket onto the wall.
4. Make the indoor station connected with the little PCB, and connect the wire correctly.
5. Connect the handset
6. Put the plug into the power socket.

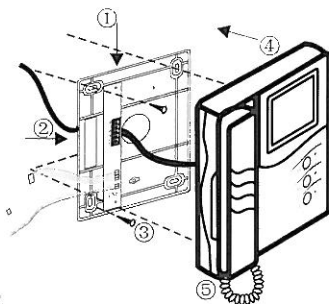

How to correct the usual faults:

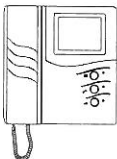
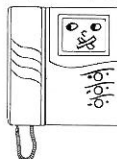
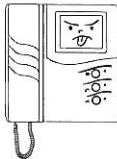
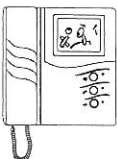
<p style="text-align: center;">No picture</p>  <ol style="list-style-type: none"> 1. Check the power plug. 2. Check the contrast if over adjusted. 3. Check the terminals if wiring is wrong. 	<p style="text-align: center;">No voice</p>  <ol style="list-style-type: none"> 1. Check the spring wire of handset. 2. Pull out the plug and insert again. 3. Check the terminals if wiring is wrong.
<p style="text-align: center;">Picture not disappear</p>  <ol style="list-style-type: none"> 1. Pull out the power plug and insert again. 2. Pick up the handset and put it down. 	<p style="text-align: center;">Picture snow</p>  <p>Check if interference around (E.g.: High voltage wire, electric equipment etc.)</p>

Specification

Outdoor Station	
Camera	1/3" CMOS/CCD
Lens and angle	F3.6mm 78° angle
Min. Illumination	0.1 LUX
Light source	4 Infrared lights
Dimension	128(L)×40(W)×30(H)mm

Indoor Station	
Power source	DC 15V
CRT	4" flat B/W
Resolution	420 TV lines
Power consumption	Max 15W
Dimension:	205(L)×215(W)×55(H)mm

Another quality product by:



PSA Products

FIRE • SECURITY • INTERCOMS

17 Millicent St, Burwood, Vic 3125 Australia
Telephone: (03) 9888 9889 Facsimile: (03) 9888 9993
e-mail: enquiry@psaproducts.com.au
website: www.psaproducts.com.au



ISO 9001 Lic 8202
Standards Australia

Outdoor station is weatherproof.